



Pressure transmitter



Huba Control

Relative and absolute pressure transmitter for shipbuilding

Type 527

The compact type 527 pressure transmitter is based upon the well proven ceramic technology developed by Huba Control over 20 years ago.

These transmitters are suitable for applications across a broad spectrum of industries and shipbuilding.

Pressure range 0 ... 1 – 60 bar

- + Compact, rugged construction
- + Negligible temperature influence on accuracy
- + Certified for shipbuilding with:
 - American Bureau of Shipping
 - Bureau Veritas
 - Det Norske Veritas Germanischer Lloyd
 - Lloyd`s Register

Technical overview

Pressure range

Relative	0 – 60 bar
Absolute	0 ... 1 – 16 bar

Operating conditions

Medium	Liquids and gases	
Temperature	Medium	FPM -15 ... +125 °C (E) -15 ... +120 °C
		EPDM -40 ... +125 °C (E) -30 ... +120 °C
		NBR -20 ... +100 °C
	Ambient	-30 ... +85 °C (E) -25 ... +85 °C
Tolerable overload / Rupture pressure	Storage	-50 ... +100 °C
	≤ 4 bar	3.0 x fs
> 4 bar	2.5 x fs	

Materials

Cover	Stainless steel 1.4404 / AISI 316L	
Plug accommodation	Polyarylamid 50% GF UL 94 V-0	
Materials in contact with medium	Pressure connection	Stainless steel 1.4404 / AISI 316L
	Sensor	Ceramic Al ₂ O ₃ (96%)
	Sealing material	FPM, EPDM, NBR

Electrical overview

	Output	Power supply	Load	Current consumption
2 wire	4 ... 20 mA	7 ... 33 VDC	< $\frac{\text{supply voltage} - 7V}{0.02 A}$ [Ohm]	< 23 mA
	(E) 4 ... 20 mA	10 ... 30 VDC	< $\frac{\text{supply voltage} - 10V}{0.02 A}$ [Ohm]	< 23 mA
3 wire	0 ... 10 V	12 ... 33 VDC	> 10 kOhm / < 100 nF	< 7 mA
Polarity reversal protection	Short circuit proof and protected against polarity reversal. Each connection is protected against crossover up to max. supply voltage.			
Insulation voltage			standard	500 VDC

Dynamic response

Response time	< 2 ms, 1 ms typ.
Load cycle	< 100 Hz

Electrical connection

Swift connector with or without cable 1.5 m (PVC spec.)

Connector DIN EN 175301-803-A

Connector M12x1

Protection standard

IP 67

IP 65

IP 67

Protection class

III

III

III

Pressure connection

Inside thread	$\frac{7}{16}$ - 20 UNF	
	$\frac{1}{2}$ - 14 NPT	
Outside thread	$\frac{7}{16}$ - 20 UNF	sealing cone 45°
	$\frac{1}{4}$ - 18 NPT	
	G $\frac{1}{4}$	sealed at back DIN EN ISO 1179-2 with Profile seal ring in FPM (-30 ... +135 °C)
	G $\frac{1}{2}$	sealed at back and manometer (combi) with Profile seal ring in FPM (-30 ... +135 °C)
	M20x1.5	sealed at front and manometer (combi)
	G $\frac{1}{2}$	sealed at front

Installation arrangement

Unrestricted

Recommendation: Pressure connection facing downwards

Tests / Admissions

Electromagnetic compatibility	CE conformity acc. EN 61326-2-3
Shock acc. IEC 68-2-27	100 g, 11 ms half sine wave, all 6 directions, free fall from 1 m on concrete (6x)
Constant shock acc. IEC 68-2-29	40 g for 6 ms, 1000x all 3 directions
Vibration acc. IEC 68-2-6	20 g, 15 ... 2000 Hz, 15 ... 25 Hz with amplitude ± 15 mm, 1 Octave/min. all 3 directions, 50 constant load
Shipbuilding	American Bureau of Shipping (ABS)
	Bureau Veritas (BV)
	Det Norske Veritas Germanischer Lloyd (DNV GL)
EAC	Lloyd`s Register (LR)

Protection against explosion (E)

Intrinsic safety «i» (with current output only)	4 ... 20 mA Ex II 1/2 G Ex ia IIC T4 Ga/Gb Ex II 1/2 D Ex ia IIC T125°C Da/Db
EC type examination certificate	SEV 10 ATEX 0145
Connection to certified intrinsically safe resistive circuits with maximum values	U _i = 30 VDC; I _i = 100 mA = P _i = 0.75 W
Effective internal inductance and capacitance for versions with plugs complying with EN 175301-803 or M12x1	L _i = 0 nH; C _i = 0 nF
IECEx	SEV 16.0007

Weight

~ 90 g

Packaging (Please state on order)

Single packaging in cardboard

accessories integrated

Multiple packaging in cardboard (25 pcs)

Accuracy

Parameter		Unit	
Characteristic line ¹⁾		% fs	± 0.3
Resolution		% fs	0.1
Thermal characteristic ²⁾	max.	% fs/10K	± 0.2
Long term stability acc. IEC EN 60770-1	max.	% fs	± 0.25

Test conditions: 25 °C, 45% RH, power supply 24 VDC

¹⁾ typ. ; max. 0.5% fs (incl. zero point, full scale, linearity, hysteresis and repeatability)

²⁾ -15 ... 85 °C

		1	2	3	4	5	6	7	8	9	10	11	
Order code selection in bar		527.	X	X	X	X	X	X	X	X	X	X	
Pressure mode	Relative	9											
	Absolute	8											
Pressure range ¹⁾	0 ... 1 bar		1	1									
	0 ... 1.6 bar		1	2									
	0 ... 2.5 bar		1	4									
	0 ... 4 bar		1	5									
	0 ... 6 bar		1	7									
	0 ... 10 bar		3	0									
	0 ... 16 bar		3	1									
	0 ... 25 bar	9	3	2									
	0 ... 40 bar	9	3	3									
	0 ... 60 bar	9	4	0									
Sealing material	FPM Fluoro elastomer				0	0							
	EPDM Ethylene propylene				1	0							
	NBR Butadiene Acrylonitrile				2	0							
Output / power supply	0 ... 10 V 12 ... 33 VDC						2						
	4 ... 20 mA 7 ... 33 VDC						3						
	10 ... 30 VDC Ex protection						4	1,3					
Electrical connection	Connector	DIN EN 175301-803-A ²⁾								1			
		M12x1 ²⁾ 2w: IN=1 / OUT=3 3w: IN=1 / OUT=4 / GND=3								3			
	M12x1 ²⁾ 2w: IN=1 / OUT=4 3w: IN=1 / OUT=3 / GND=4									M			
	Swift connector with cable 1.5 m									L			
Pressure connection	Inside thread	7/16 - 20 UNF								K	1	1	
		1/2 - 14 NPT								D	1	1	
	Outside thread	7/16 - 20 UNF									2	1	1
		1/4 - 18 NPT									3	1	1
		G 1/4 sealed at back DIN EN ISO 1179-2 with Profile seal ring in FPM									4	1	1
		G 1/2 sealed at back and manometer with Profile seal ring in FPM									8	1	1
		M20x1.5 sealed at front and manometer (combi)									E	1	1
G 1/2 sealed at front									9	1	1		
Pressure range variation (optional)	Indicate W and state range on order (e.g.: W0... + 3bar/OUT0...5V)												
												W	

		1	2	3	4	5	6	7	8	9	10	11	
Order code selection in psi		527.	X	X	X	X	X	X	X	X	X	X	
Pressure mode	Relative	9											
	Absolute	8											
Pressure range ¹⁾	0 ... 15 psi		B	1									
	0 ... 20 psi		B	2									
	0 ... 30 psi		B	4									
	0 ... 60 psi		B	5									
	0 ... 100 psi		B	7									
	0 ... 150 psi		C	0									
	0 ... 200 psi		C	1									
	0 ... 300 psi	9	C	2									
	0 ... 500 psi	9	C	3									
	0 ... 750 psi	9	D	0									
Sealing material	FPM Fluoro elastomer				0	0							
	EPDM Ethylene propylene				1	0							
	NBR Butadiene Acrylonitrile				2	0							
Output / power supply	0 ... 10 V 12 ... 33 VDC						2						
	4 ... 20 mA 7 ... 33 VDC						3						
	10 ... 30 VDC Ex protection						4	1,3					
Electrical connection	Connector	DIN EN 175301-803-A ²⁾								1			
		M12x1 ²⁾ 2w: IN=1 / OUT=3 3w: IN=1 / OUT=4 / GND=3								3			
	M12x1 ²⁾ 2w: IN=1 / OUT=4 3w: IN=1 / OUT=3 / GND=4									M			
	Swift connector with cable 1.5 m									L			
Pressure connection	Inside thread	7/16 - 20 UNF								K	1	1	
		1/2 - 14 NPT								D	1	1	
	Outside thread	7/16 - 20 UNF									2	1	1
		1/4 - 18 NPT									3	1	1
		G 1/4 sealed at back DIN EN ISO 1179-2 with Profile seal ring in FPM									4	1	1
		G 1/2 sealed at back and manometer with Profile seal ring in FPM									8	1	1
		M20x1.5 sealed at front and manometer (combi)									E	1	1
G 1/2 sealed at front									9	1	1		
Pressure range variation (optional)	Indicate W and state range on order (e.g.: W0... + 16psi/OUT0...5V)												
												W	

¹⁾ Other pressure ranges on request

²⁾ Delivery without female connector

Order code selection in MPa		1	2	3	4	5	6	7	8	9	10	11	
		527. X X X X X X X X X X X X											
Pressure mode	Relative	9											
	Absolute	8											
Pressure range ¹⁾	0 ... 0.1 MPa		G	1									
	0 ... 0.16 MPa		G	2									
	0 ... 0.25 MPa		G	4									
	0 ... 0.4 MPa		G	5									
	0 ... 0.6 MPa		G	7									
	0 ... 1 MPa		H	0									
	0 ... 1.6 MPa		H	1									
	0 ... 2.5 MPa	9	H	2									
	0 ... 4 MPa	9	H	3									
	0 ... 6 MPa	9	K	0									
Sealing material	FPM Fluoro elastomer				0	0							
	EPDM Ethylene propylene				1	0							
	NBR Butadiene Acrylonitrile				2	0							
Output / power supply	0 ... 10 V 12 ... 33 VDC							2					
	4 ... 20 mA 7 ... 33 VDC							3					
	10 ... 30 VDC Ex protection							4	1,3				
Electrical connection	Connector									1			
	M12x1 ²⁾ 2w: IN=1 / OUT=3 3w: IN=1 / OUT=4 / GND=3									3			
	M12x1 ²⁾ 2w: IN=1 / OUT=4 3w: IN=1 / OUT=3 / GND=4									M			
	Swift connector with cable 1.5 m									L			
Pressure connection	Inside thread	7/16" - 20 UNF								K	1	1	
		1/2" - 14 NPT								D	1	1	
	Outside thread	7/16" - 20 UNF									2	1	1
		1/4" - 18 NPT									3	1	1
		G 1/4 sealed at back DIN EN ISO 1179-2 with Profile seal ring in FPM									4	1	1
		G 1/2 sealed at back and manometer with Profile seal ring in FPM									8	1	1
		M20x1.5 sealed at front and manometer (combi)									E	1	1
G 1/2 sealed at front									9	1	1		
Pressure range variation (optional)	Indicate W and state range on order (e.g.: W0... + 0.3MPa/OUT0...5V)											W	

Accessories (supplied loose)	Order number
Female connector DIN EN 175301-803-A with seal	103510
Corner-wire box for connector M12x1	106975
Corner-wire box for connector M12x1 with cable 2.0 m	114604
Straight-wire box for connector M12x1	114570
Straight-wire box for connector M12x1 with cable 2.0 m	114605
Mounting bracket with screw	118716
Heat sink with outside thread G 1/2 sealed at front - inside thread G 1/2	105631
Heat sink with outside thread G 1/2 sealed at front - inside thread G 1/4	105073
Heat sink with outside thread G 1/4 sealed at front - inside thread G 1/4	105074
Calibration certificate	104551

Mounting bracket

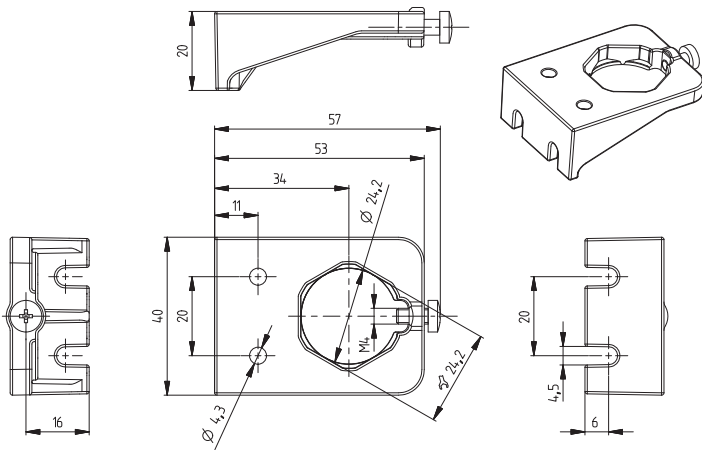

Heat sink

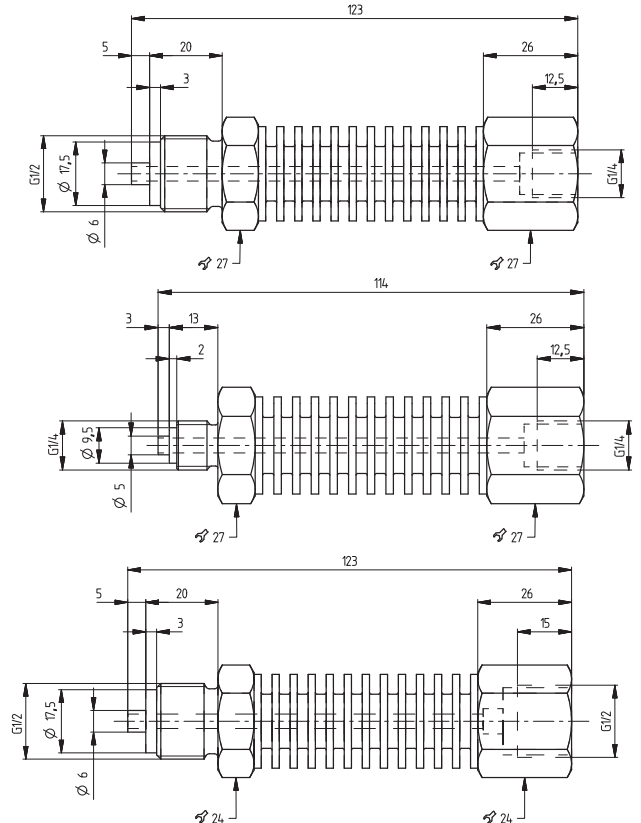

¹⁾ Other pressure ranges on request

²⁾ Delivery without female connector

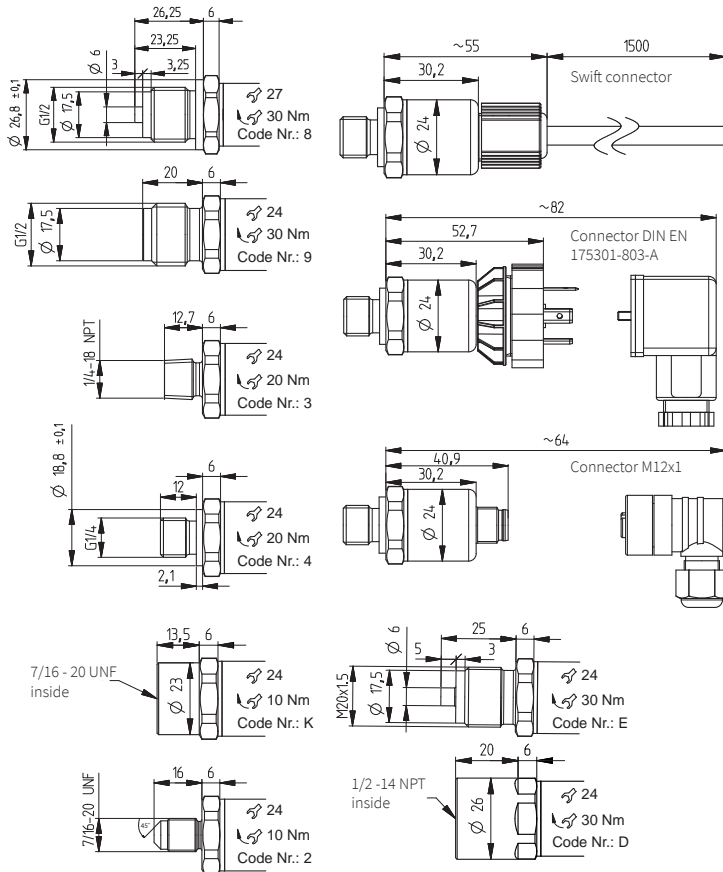

2 wire

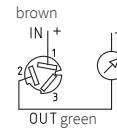

1 (IN) 2 (OUT)

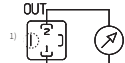

1 (IN) 2 (OUT)

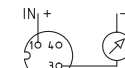

1 (IN) 3 (OUT)

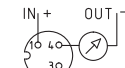

1 (IN) 4 (OUT)

3 wire

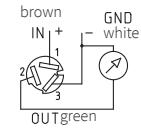

1 (IN) 2 (OUT) 3 (GND)

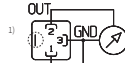

1 (IN) 2 (OUT) 3 (GND)

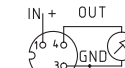

1 (IN) 4 (OUT) 3 (GND)

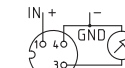

1 (IN) 3 (OUT) 4 (GND)



Device design with explosion protection: 4 ... 20 mA
The grounding connection is conductively connected to the transmitter housing.

Connector DIN EN 175301-803-A

Connector M12x1

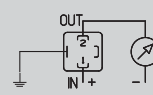

1 (IN) 2 (OUT) ↓

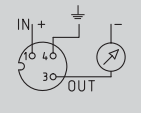

1 (IN) 3 (OUT) 4 (↓)



株式会社 **クローネ**

■カタログに掲載してある製品の色は印刷インキの関係上、実際とは異なる場合があります。
■製品のデザイン、仕様等などは、予告なく変更する場合があります。

本 社：〒124-0023 東京都葛飾区東新小岩3丁目9番6号 TEL: (03) 3695-5431 / FAX: (03) 3695-5698
大阪支店：〒530-0054 大阪市北区南森町2-2-9(南森町八千代ビル7F) TEL: (06) 6361-4831 / FAX: (06) 6361-9360
e-mail: sales-tokyo@krone.co.jp URL: <https://www.krone.co.jp>

www.hubacontrol.com

