

Relative and absolute pressure transmitter type 680

Pressure range
0 ... 0.1 – 1000 bar



The pressure transmitters of type 680 with piezoresistive measuring elements have compensated, calibrated and amplified sensor signals which are available as standard voltage or current outputs.

The transmitter housing is available with various pressure and electrical connections.

Manufactured from stainless steel, its welded construction provides a watertight seal. With its sophisticated building block system, individual designs to meet specific applications are possible.

- Effective overload protection due to chemically etched chip diaphragm and specially designed glass gland
- Fast and affordable customer specific solutions due to building block system, even for small quantities
- Compact construction with SMD technology enhances operational reliability in the presence of shock and vibration
- Welded construction provides 100% sealing against media

Technical overview

Pressure type ¹⁾

Relative and absolute	0 ... 25 bar
Overpressure	> 25 ... 1000 bar

Overload

At Pressure ranges 0.1 ... 2 bar	3x pressure range, min. 3 bar
At Pressure ranges > 2 ... 600 bar	3x pressure range, max. 850 bar
At Pressure ranges > 600 ... 1000 bar	1500 bar

Rupture pressure

At Pressure ranges 0.1 ... 2 bar	> 200 bar
At Pressure ranges > 2 ... 600 bar	> 850 bar
At Pressure ranges > 600 ... 1000 bar	> 1500 bar

Medium

Permissible medium	liquids and gases
--------------------	-------------------

Material

Pressure connection, diaphragm, case	stainless steel 1.4435 (316L) (Titanium or Hastelloy C on request)
Sealing material	FPM (other on request)

Temperature ²⁾

Medium temperature	-40 ... +150 °C
Ambient temperature	-40 ... +125 °C
Storage temperature	-40 ... +125 °C

Output and power supply ^{3) 4)}

	output	power supply	permissible load ⁵⁾
3-wire	0 ... 5 V	12 ... 30 VDC	> 10 kOhm
	0 ... 10 V	12 ... 30 VDC	> 10 kOhm
2-wire	4 ... 20 mA	9 ... 33 VDC	$\frac{\text{supply voltage} - 9V}{0.02 A}$ [Ohm] max.
2-wire (Ex)	4 ... 20 mA	9 ... 28 VDC	$\frac{\text{supply voltage} - 9V}{0.02 A}$ [Ohm] max.

Ex-Version

Ex-Admission (Depending on execution, see valid ATEX certificate)	gas	II 1G Ex ia IIB/IIC T3 ... T6	II 1D Ex iaD 20 IP6x T145 ... T70 °C
Standards		EN 60079-0 / EN 60079-11	EN 61241-0 / EN 61241-11

Temperature class Ex-Version

	T6	T4	T3
Ambient temperature Ta	-40 ... +50 °C	-40 ... +85 °C	-40 ... +125 °C
Medium temperature	-40 ... +50 °C	-40 ... +110 °C	-40 ... +150 °C

Electrical connection

Cable	PUR, PE or Teflon in variable lengths ⁶⁾
Connector ⁷⁾	DIN EN 175301-803-A / Lumberg RSF 4 / RSF 50 / Binder 723

Pressure connection

Inside thread	G ¼ ¹⁾
Outside thread	G ¼, G ½ ¹⁾

Tests / Admissions

	norm	character	level
Mechanical load	EN 60068-2-6	vibration	10 g (4 ... 2000 Hz, oscillation ± 10 mmpp)
	EN 60068-2-27	shock	100 g (pulse duration 6 ms)
Interference emit	EN 55022	emitted interference, class B	< 30 dBµV/m (0.03 ... 1 GHz)
	EN 61000-4-2	discharge static electricity	8 kV contact-, 15 kV air discharge
	EN 61000-4-3	electromagnetic radiation	10 V/m, 0.08 ... 2.7 GHz, 80% AM 1 kHz, 3s
Interference resistance	EN 61000-4-4	fast transients (burst)	4 kV
	EN 61000-4-5	impulse voltage (surge)	Line-Line 0.5 kV/42 Ohm, Line-Earth 1 kV/42 Ohm
	EN 61000-4-6	grid-bound electromagnetic blockage	10 V, 0.15 ... 80 MHz, 80% AM 1 kHz, 3s

Packaging

Single packaging	carton padded cellular material
------------------	---------------------------------

Weight

Cable version (2 m)	~ 250 g
Connector version	~ 150 g

Accuracy

	total error band ⁽¹⁾ [±%fs] per pressure ranges [bar]				
	0.1 ... 0.5	> 0.5 ... 2	> 2 ... 100	> 100 ... 600	> 600 ... 1000
Characteristic line deviation [±%FS] 0.25 or 0.1 (typ./ max.) 0 ... +70 °C	1.0 / 1.5	0.7 / 1.0	0.7 / 1.0	0.7 / 1.0	0.7 / 1.0
(typ./ max.) -25 ... +100 °C	2.0 / 2.5	1.0 / 1.5	1.0 / 1.5	1.0 / 1.5	1.0 / 1.5
Characteristic line deviation [±%FS] 0.05 (typ. / max.) 0 ... +70 °C	–	0.3 / 0.5	0.3 / 0.5	–	–
(typ. / max.) -25 ... +100 °C	–	0.75 / 1.0	0.75 / 1.0	–	–

⁽¹⁾ total error band incl. characteristic line deviation, temperature error zero point and operating range, hysteresis and repeatability at max. signal range.

¹⁾ See order code selection table. Other on request

⁴⁾ Influence from the supply voltage types < 0.05% fs

⁷⁾ Delivery without female connector

²⁾ Compensated temperature range see order code selection table

⁵⁾ Influence permissible load < 0.05% fs

³⁾ Short circuit proof with polarity reversal protection

⁶⁾ Standard length 2 m

		1	2	3	4	5	6	7	8	9	10
Order code selection table		680. X X X X X X X X X X									
Pressure type	Relative	8									
	Absolute	7									
Pressure range ¹⁾	Overpressure	6									
	0 ... 100 mbar		0	0							
	0 ... 160 mbar		0	1							
	0 ... 250 mbar		0	2							
	0 ... 400 mbar		0	3							
	0 ... 600 mbar		0	4							
	0 ... 1 bar		0	5							
	0 ... 1.6 bar		0	6							
	0 ... 2.5 bar		0	7							
	0 ... 4 bar		0	8							
	0 ... 6 bar		0	9							
	0 ... 10 bar		1	0							
	0 ... 16 bar		1	1							
	0 ... 25 bar		1	2							
	0 ... 40 bar	6	1	3							
	0 ... 60 bar	6	1	4							
	0 ... 100 bar	6	1	5							
	0 ... 160 bar	6	1	6							
	0 ... 250 bar	6	1	7							
	0 ... 400 bar	6	1	8							
0 ... 600 bar	6	1	9								
0 ... 1000 bar	6	2	0								
Output / power supply	0 ... 5 V 12 ... 30 VDC					0					
	0 ... 10 V 12 ... 30 VDC					1					
	4 ... 20 mA 9 ... 33 VDC					3					
	4 ... 20 mA 9 ... 28 VDC intrinsically safe version ^{2) 3)}					4					
Characteristic line deviation	≤ ± 0.25% fs						1				
	≤ ± 0.10% fs (≤ 600 bar fs)						2				
	≤ ± 0.05% fs (≥ 0.5 bar ... ≤ 100 bar fs)			3,4	3			0,1,2,3			
Temperature range	0 ... + 70 °C compensated, medium temperature permissible: -40 ... +125 °C							0			
	-25 ... + 100 °C compensated, medium temperature permissible: -40 ... +125 °C							1			
	-25 ... + 100 °C compensated, medium temperature permissible: -40 ... +150 °C							2			
	-40 ... + 125 °C compensated, medium temperature permissible: -40 ... +125 °C							3			
	Ex T6 (Ta: -40 ... +50 °C) 0 ... +70 °C compensated (medium temperature permissible: - 40 ... + 50 °C)			4				4			
	Ex T4 (Ta: -40 ... +85 °C) -25 ... +100 °C compensated (medium temperature permissible: - 40 ... + 110 °C)			4				5			
Electrical connection	Connector	Fig. 1 Binder 723 5 pin IP 67								0	
		Fig. 2 DIN EN 175301-803-A IP 65								1	
		Fig. 3 Lumberg 4 pin RSF 4 IP 20								2	
		Fig. 4 Lumberg 5 pin RSF 50 IP 68	6,7							3	
	Cable ⁴⁾	Fig. 5 PUR IP 67								4	
		Fig. 6 PUR with kink guard IP 67								5	
	Fig. 5 Teflon IP 67								9		
Pressure connection	Inside thread	Fig. 10 G ¼								0	0
		Fig. 11 G ¼								0	1
	Outside thread	Fig. 12 G ¼ manometer DIN 16288								0	2
		Fig. 13 G ½								0	3
		Fig. 14 G ½ diaphragm at front								0	4
		Fig. 15 G ½ diaphragm flush with front								0	5
	Fig. 16 G ½ manometer DIN 16288								0	6	
Version											N

¹⁾ Other pressure ranges on request

²⁾ II 1G Ex ia IIB/IIC T3...T6 / II 1D Ex iaD 20 IP6x T145...T70°C (Depending on execution, see valid ATEX certificate)

³⁾ Indicate correct medium

⁴⁾ Length of cable 2 m (other lengths on request)

Fig. 10

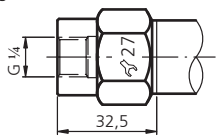

Fig. 11

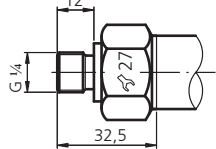

Fig. 12

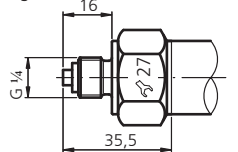

Fig. 13

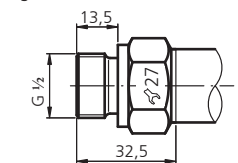

Fig. 14

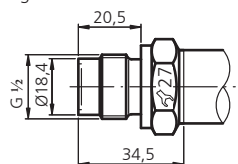

Fig. 15

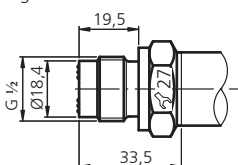
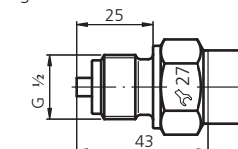
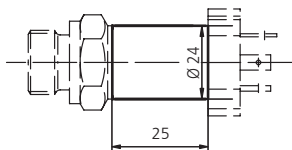

Fig. 16



Version for medium temperature up to +125 °C



Version for medium temperature > +125 ... max. +150 °C

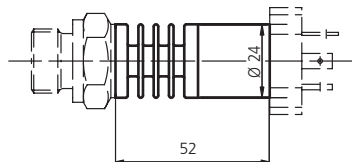

Fig. 1

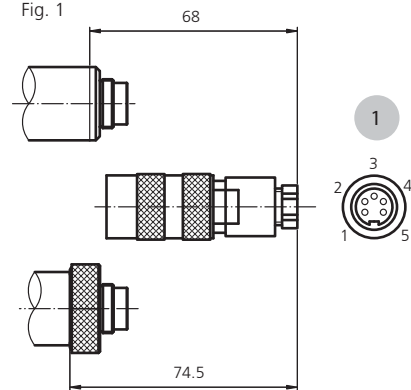

Fig. 2

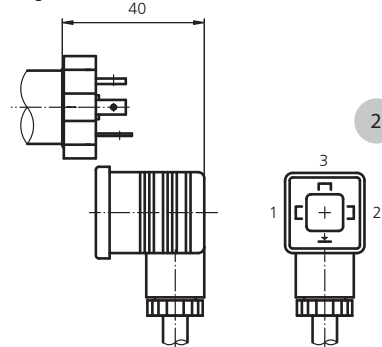

Fig. 3

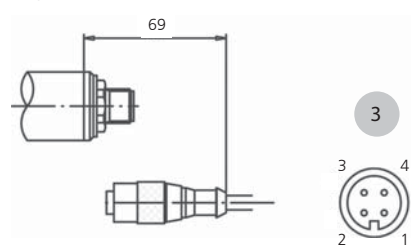

Fig. 4

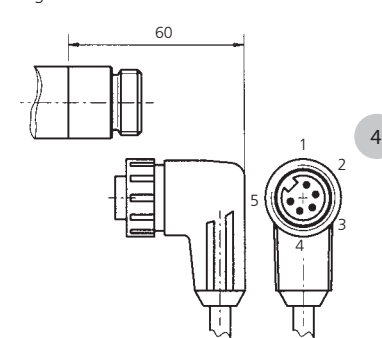

Fig. 5

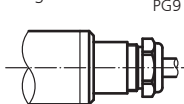
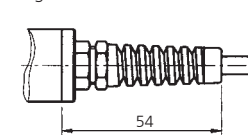

Fig. 6



	Pin / Colour	2-wire	3-wire
1	1	OUT	OUT
	3	IN	IN
	4		GND
2	1	IN	IN
	2	OUT	OUT
	3		GND
3	1		GND
	3	OUT	OUT
	4	IN	IN
4	1	OUT	OUT
	3	IN	IN
	4		GND
5	white	IN	IN
	yellow	OUT	GND
	brown		OUT

Huba Control

FOR FINE PRESSURE AND FLOW MEASUREMENT



株式会社 **クローネ**

■カタログに掲載してある製品の色は印刷インキの関係上、実際とは異なる場合があります。
■製品のデザイン、仕様等などは、予告なく変更する場合があります。

本 社：〒124-0023 東京都葛飾区東新小岩3丁目9番6号 TEL: (03) 3695-5431 / FAX: (03) 3695-5698
大阪支店：〒530-0054 大阪市北区南森町2-2-9(南森町八千代ビル7F) TEL: (06) 6361-4831 / FAX: (06) 6361-9360
e-mail: sales-tokyo@krone.co.jp URL: <https://www.krone.co.jp>