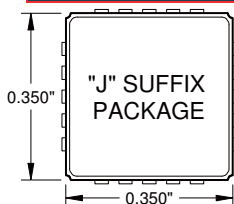

- Small Bias and SF Temperature Coefficients
- Excellent In-Run Bias Stability
- Zero Cross Coupling by Design
- Low Power +5 VDC, 6.5 mA
- -55 to +125°C Operation
- ±4V Differential Analog Output
- Internal Temperature Sensor
- Nitrogen Damped & Hermetically Sealed
- Small J-Lead LCC-20 Ceramic Package, Mass 0.68 g
- Serialized for Traceability & RoHS Compliant

AVAILABLE G-RANGES

FULL SCALE ACCELERATION	20 PIN J-LCC
± 10 g	1527J-010
± 25 g	1527J-025
± 50 g	1527J-050

DESCRIPTION

The Model 1527 is a small, lightweight, integrated MEMS accelerometer for use in tactical-grade inertial applications requiring high repeatability, low noise, and long-term stability in -55 to +125°C environments. The Model 1527 accelerometers are fully designed and built by SDI in the USA, and each unit is individually tested, calibrated and verified for performance.

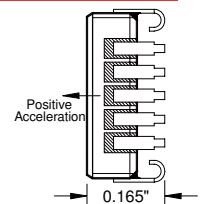

Each miniature, hermetically sealed package combines a MEMS capacitive sense element and a custom integrated circuit that includes a sense amplifier and differential output stage. Each device is marked with a serial number on its top and bottom surfaces for traceability. Documentation is supplied with each unit showing the residuals, thermal sensor model, acceleration model, bias, scale factor, linearity, operating current, & frequency response.

ZERO (DC) TO MEDIUM FREQUENCY APPLICATIONS

DESIGN SPECIFICATIONS

PARAMETER	TYPICAL VALUE/RANGE +/-10G	TYPICAL VALUE/RANGE +/-25G	TYPICAL VALUE/RANGE +/-50G	UNITS
Vibration Rectification, typical				
Random, 10-50 Hz	TBA	30	TBA	µg/g ² rms
Random, 50-200 Hz		100		
Velocity Random Walk	0.007	0.012	0.025	m/sVHr ^{1/2}
Bias, Long Term Repeatability (1σ)	1.25	1.50	3.0	mg
In Run Bias Stability at +1g, 2-40,000 sec. (AV Min)	12	30	60	µg
Scale Factor Long Term Repeatability (1σ)	300	300	300	PPM
Output White Noise	18	25	50	µg/√Hz ^{1/2} rms
Temperature Sensor Sensitivity (IT Pin 7)	1.2 to 1.8	1.2 to 1.8	1.2 to 1.8	uA/C
Temperature Sensor Noise	0.33 RMS typ	0.33 RMS typ	0.33 RMS typ	C
Turn-On Time < 150 ppm of FS	0.5	0.5	0.5	msec
Operating Voltage	4.75 to 5.25	4.75 to 5.25	4.75 to 5.25	Volts
Input Axis Misalignment	4	4	4	mrad
Peak Vibration (Operating and Non-operating)	200%	200%	200%	FS

Design specifications are inherent in the design and not tested during manufacturing

SPECIFICATIONS SUBJECT TO CHANGE WITHOUT NOTICE

TESTED PERFORMANCE SPECIFICATIONS

PARAMETER	LIMIT +/-10G	LIMIT +/-25G	LIMIT +/-50G	UNITS
Bias	+/- 0.5	+/- 0.5	+/- 0.5	% of FS
Bias Temperature Coefficient	±25	±15	±15	PPM of FS/°C
Scale Factor Sensitivity, +/-0.5%	400	160	80	mV/g
Scale Factor Temperature Coefficient	±25	±25	±25	PPM/ °C
Frequency Response, DC to -3 dB, Minimum*	420	660	1050	Hz
RMS Model Residual (+/- 1g, -40, +25, +85°C)	30	25	25	PPM of FS

*Frequency Response reported as performance once soldered. Simulating Frequency Response with the DV pin will report lower values than actual performance once soldered.

MAX OPERATING LIMITS

PARAMETER	MINIMUM	MAXIMUM	UNITS
Differential Output	-4.0	+4.0	Volts
Operating Voltage	4.75	5.25	Volts
Quiescent Operating Current at +5V	----	6.5	mA
Operating / Storage Temperature	-55	+125	°C
Applied Voltage on Digital Pins	-0.5	5.5	Volts
Mechanical Shock (0.1 ms)	----	5,000	g-peak
Peak Vibration (Operating and Non-operating)	----	200	% of FS

FS = Full Scale = 4V absolute differential output = 4000 mV

NOTICE: Stresses greater than those listed above may cause permanent damage to the device. These are maximum stress ratings only. Functional operation of the device at or above these conditions is not implied. Exposure to absolute maximum rating conditions for extended periods may affect device reliability and lifespan.

OPERATION

The model 1527 sensitive axis is perpendicular to the bottom of the package, with positive acceleration resulting from a positive force pushing on the bottom of the package. The seismic center is located on a centerline through the dual sense elements and halfway between them.

The Model 1527 produces a differential +/-4 volts output voltage, the value of which varies with acceleration as shown in figure 1. The seismic center is located on a centerline through the dual sense elements halfway between them. Any errors due to rotation about this point are effectively cancelled by the internal electronics

Two reference voltages, +5.0 and +2.5 volts (nominal), are required; scale factor is ratiometric to the +5.0 volt reference voltage relative to GND, and both outputs at zero acceleration are nominally 80 mV below the +2.5 volt input.

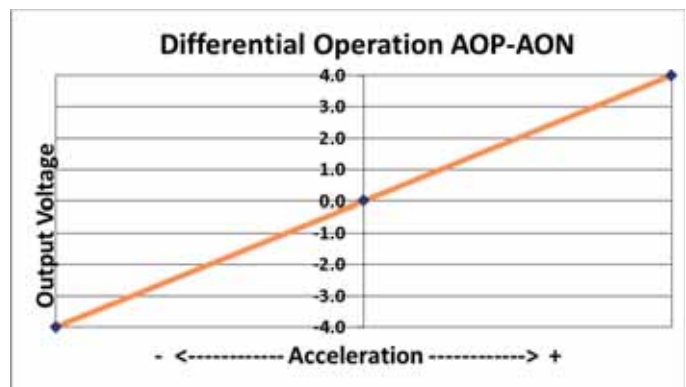

*The 1527 should not be used in
Single Ended mode*

SPECIFICATIONS SUBJECT TO CHANGE WITHOUT NOTICE

SAMPLE OF INCLUDED TEST REPORT

Every 1527 accelerometer is accompanied by a test report featuring the measured bias, scale factor, linearity, output, and frequency and phase response.

ACCELEROMETER TEST REPORT

Model 1527J-025	Supply Current (I _{dd}) 5.37 mA	Part # 172-00212-02
Full Scale 25 g	Scale Factor (Sensitivity) 160.3 mV/G	Doc. Rev. -
Cal. Date 08/28/19	0 G Bias (Offset) -1 mV	Mfg. Lot # 19A080D
Serial # #####		Operator H
		Op. Number 120

Linearity and Output*

The graph shows a linear relationship between Applied G Level and Differential Out (V). The error (% of span) remains consistently near 0% across the range.

Frequency and Phase Response**

The graph shows Gain (dB) and Phase (deg) vs Frequency (Hz). Gain remains flat at 0 dB until approximately 1000 Hz, then drops. Phase starts near 0 degrees and drops to -167.5 degrees at 3000 Hz.

Freq. (Hz)*	20	50	90	170	320	600	830	970	1140	1340	1580	1850	2170	3000
dB Out - X	0.00	0.00	0.00	0.01	0.06	0.12	0.01	-0.23	-0.76	-1.75	-3.36	-5.46	-7.99	-13.76
Phase (deg)	-1.2	-3.1	-5.5	-10.4	-19.8	-38.7	-56.0	-67.4	-81.4	-97.4	-114.5	-130.2	-144.4	-167.5

* Peak Acceleration Traceable to SDI Shaker System Test Interface M90257
** Reference Frequency is 100 Hz

**Final Status
Pass:**

www.silicondesigns.com
sales@silicondesigns.com
+1-425-391-8329

SIGNAL DESCRIPTIONS

V_{DD} and GND (power): Pins (14) and (19) respectively. Power (+5 Volts DC) and ground.

AOP and AON (output): Pins 12 and 16 respectively. Analog output voltages proportional to acceleration. The AOP voltage increases (AON decreases) with positive acceleration; at zero acceleration both outputs are nominally equal to the +2.5 volt reference. The device experiences positive (+1g) acceleration with its lid facing up in the earth's gravitational field. Use of differential mode is required for both low noise and high accuracy operation. Voltages can be measured ratio-metrically to VR for good repeatability without requiring a separate precision reference voltage for an A/D.

DV (input): Pin 4. Deflection Voltage. Connect to the 2.5 Volt pin for best repeatability. A test input that applies an electrostatic force to the sense element, simulating a positive acceleration. The nominal voltage at this pin is $\frac{1}{2}$ V_{DD}. DV voltages higher than required to bring the output to positive full scale may cause device damage to 2g, 5g, and 10g devices. See app note.

VR (input and Ref GND): Pin 3. Voltage Reference. Tie VR to a good reference (not directly to V_{DD}) for best scale factor repeatability. A 0.1 μ F bypass capacitor is recommended at this pin. VR current is less than 100 μ A. Ref GND can be connected to pin 19. However, to minimize 1/f noise, connect pin 20 separately to the ground of the voltage reference ground pin.

2.5 Volt (input): Pin 17. Sets output common-mode value. Tie to a resistive voltage divider from +5 volts. A 0.1 μ F bypass capacitor is recommended at this pin. VR current is less than 50 μ A.

I_T (output): Pin 7. Uncalibrated temperature dependent current source. Tie to V_{DD} if not used.

CLKIN: Pin 8. Optional external clock input, leave unconnected or contact SDI for details on this feature.

Special Use Pins: Pins 9 and 11 should be tied to V_{DD}; Pins 2,5,6 and 18 to GND; Pins 1,7,10,13, and 15 are reserved and should remain unused. Contact SDI for possible special use of these pins.

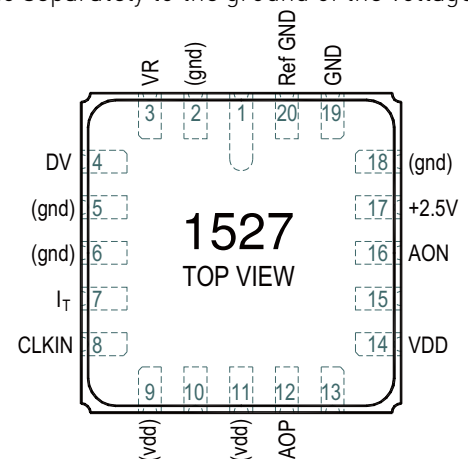

INTERNAL CLOCK

The model 1527 contains an internal clock that runs at approximately 900 KHz. The internal clock is powered by V_{DD}. Like other synchronous sensors, it is subject to clock "lock-in" with other accelerometers driven by the same V_{DD}. To avoid possible lock-in and small bias jumps, it is recommended that the V_{DD} power to each accelerometer be supplied by separately buffered sources or filtered from a common well bypassed source by a LC filter with a minimum of 20 dB loss at 800 KHz. Alternatively, multiple accelerometers can be driven by the same external clock with a frequency in the range of 0.5 to 1 MHz. Contact SDI for more information on using an external clock.

RECOMMENDED CONNECTIONS

DEFLECTION VOLTAGE (DV) TEST

INPUT: This test input applies an electrostatic force to the sense element, simulating a positive acceleration of up to +10g. It has a nominal input impedance of 32 kΩ and a nominal open circuit voltage of $\frac{1}{2} V_{DD}$. For best accuracy during normal operation, this input should be left unconnected or connected to a voltage source equal to $\frac{1}{2}$ of the V_{DD} supply.

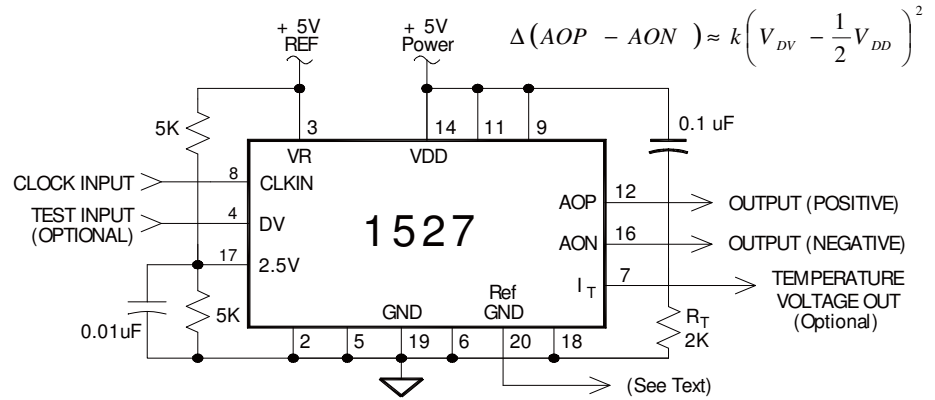

The change in differential output voltage (AOP - AON) is proportional to the square of the difference between the voltage applied to the DV input (V_{DV}) and $\frac{1}{2} V_{DD}$. Only positive shifts in the output voltage may be generated by applying voltage to the DV input. When voltage is applied to the DV input on 2g, 5g, and 10g devices, it should be applied gradually. The application of DV voltages greater than required to bring the output to positive full scale may cause device damage. The proportionality constant (k) varies for each device and is not trimmed to a value.

ESD and LATCH-UP CONSIDERATIONS: The model 1527 accelerometer is a CMOS device subject to damage from large electrostatic discharges. Diode protection is provided on the inputs and outputs, and it is not easily damaged, but care should be exercised during handling. However, individuals and tools should be grounded before coming in contact with the device. Although the 1527 is resistant to latch-up, inserting a 1527 into or removing it from a powered socket may cause damage.

INTERNAL TEMPERATURE SENSING

The model 1527 accelerometer outputs a temperature dependent current source on pin 8. This signal is useful for measuring the internal temperature of the accelerometer so that any previously characterized bias and scale factor temperature dependence, for a particular accelerometer, can be corrected. The nominal output current at 25°C is ≈ 500 (± 200) μA and the nominal sensitivity is 1.5 (± 0.5) $\mu A/^\circ C$. With a single resistor $R_T = 2K$ between I_T (pin 8) and GND the output voltage V_T will vary between +0.76 and +1.3 volts from -55 to +125°C, which equates to a sensitivity of $\approx +3$ mV/°C.

$$V_T \approx R_T [(500 \mu A) + [(1.5 \mu A)(T - 25)]] \quad \frac{\Delta V_T}{\Delta T} = R_T (1.5 \mu A)$$

$$R_{OFF} = \frac{-V_{OFF}}{\left(\frac{V_T}{R_G}\right) + (500 \mu A) + [(1.5 \mu A)(T - 25)]}$$

$$V_T \approx -R_G \left[\frac{V_{OFF}}{R_{OFF}} + (500 \mu A) + [(1.5 \mu A)(T - 25)] \right]$$

$$\frac{\Delta V}{\Delta T} = -R_G (1.5 \mu A) \quad R_G = \frac{-\Delta V_T}{(1.5 \mu A)(\Delta T)}$$

	MIN	TYP	MAX	UNITS
Temperature Sensor	0.25	0.25	0.25	°C rms
White Noise (1-1000 Hz):				

If a greater voltage change versus temperature or lower signal source impedance is needed, add the amplifier as shown on the right side in Figure 2. With offset voltage $V_{OFF} = -5V$, gain resistor $R_G = 15.0K$ and offset resistor $R_{OFF} = 7.32K$, the output voltage V_T will vary between +4.5 and +0.5 Volts from -55 to +125°C, which equates to a sensitivity of ≈ -29 mV/°C. Figure 3 shows the voltage compliance of the temperature dependent current source (I_T) at room temperature. The voltage at pin 8 must be kept in the 0 to +3V range in order to achieve proper temperature readings.

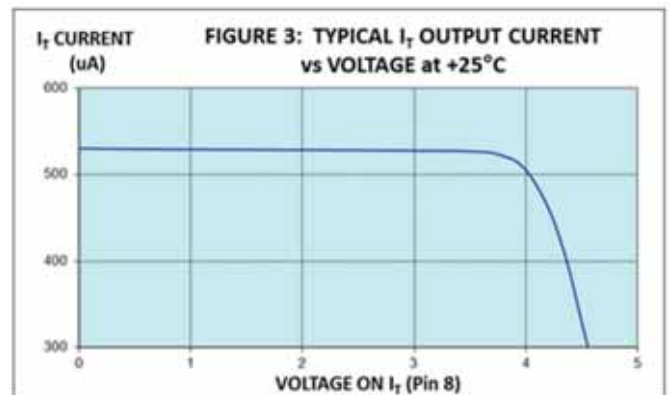

Keep Pin 8 voltage in 0 to +3V range for proper readings.

SPECIFICATIONS SUBJECT TO CHANGE WITHOUT NOTICE

SOLDERING RECOMMENDATIONS

RoHS Compliance: The model 1527 does not contain elemental lead and is RoHS compliant.

Pre-Tinning of Accelerometer Leads is Recommended: To prevent gold migration embrittlement of the solder joints, it is best to pre-tin the accelerometer leads.

Soldering: Solder reflow should not exceed 239°C, exceeding this temperature may result in permanent damage.

J-LCC Solder Contact Plating Information: The plating composition and thickness for the solder pads and castellations on the J-Lead package top layer are 100 to 225 micro inches thick of 99.7% gold (Au) over 80 to 350 micro inches thick of electroplated nickel (Ni).

These dimensions are recommendations only and may or may not be optimal for your soldering process.

Do not use ultrasonic cleaners.

Ultrasonic cleaning voids the warranty and may break internal wire bonds.

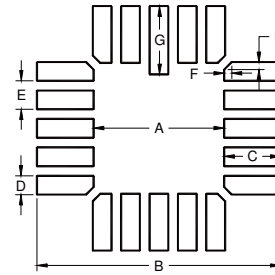

DIM	Inch	mm
A	.230	5.84
B	.430	10.92
C	.100	2.54
D	.033	0.84
E	.050	1.27
F	.013	0.33
G	.120	3.05

PACKAGE DIMENSIONS

- *Dimensions "M," "T," and "U" locate sensing element's center of mass.
- Lid is electrically tied to terminal 19 (GND).
- Controlling dimension: Inch.
- Terminals are plated with 60 micro inches min gold over 80 micro inches min nickel. This plating specification does not apply to the Pin-1 identifier mark on the bottom of the J-lead package version.
- Package: 90% min alumina (black), lid: solder sealed Kovar.

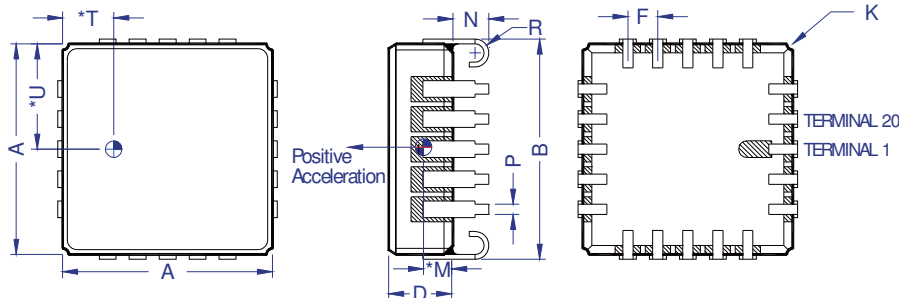

Dim	Inches		Millimeters	
	Min	Max	Min	Max
A	0.342	0.358	8.69	9.09
B	0.346	0.378	8.79	9.60
D	0.095	0.115	2.41	2.92
F	0.050 BSC		1.27 BSC	
K	0.010 R TYP		0.25 R TYP	
* M	0.066 TYP		1.68 TYP	
N	0.050	0.070	1.27	1.78
P	0.017 TYP		0.43 TYP	
R	0.023 R TYP		0.58 R TYP	
* T	0.085 TYP		2.16 TYP	
* U	0.175 TYP		4.45 TYP	
Mass 0.68 g				

COMPANION ACCESSORY

The SDI Model 2227 Q-Module combines a high-temperature, open printed circuit board (PCB) specifically designed to give the high stability required for inertial applications and SDI's Model 1527 Tactical-Grade Inertial Navigation MEMS Accelerometer. It is a low-mass, low-power module, electrically and mechanically compatible with fixtures and equipment designed for industry-standard quartz accelerometers and intended for use in inertial and tilt applications requiring zero to medium frequency response excellent long-term bias and scale factor repeatability, and low noise.

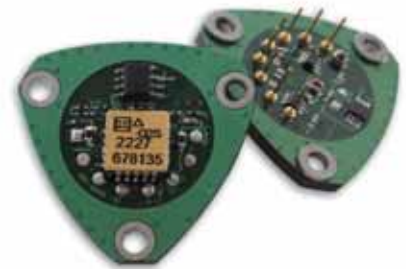

株式会社 **クローネ**

■カタログに掲載してある製品の色は印刷インキの関係上、実際とは異なる場合があります。
■製品のデザイン、仕様等などは、予告なく変更する場合があります。

本 社：〒124-0023 東京都葛飾区東新小岩3丁目9番6号 TEL: (03) 3695-5431 / FAX: (03) 3695-5698
大阪支店：〒530-0054 大阪市北区南森町2-2-9(南森町八千代ビル7F) TEL: (06) 6361-4831 / FAX: (06) 6361-9360
e-mail: sales-tokyo@krone.co.jp URL: <https://www.krone.co.jp>

SPECIFICATIONS SUBJECT TO CHANGE WITHOUT NOTICE