



MS5837-30BA

Ultra-small, gel-filled, pressure sensor with stainless steel cap

The MS5837-30BA is a high-resolution pressure and temperature sensor from TE Connectivity (TE) with I²C bus interface. This sensor is optimized for water depth measurement systems with a resolution of 0.2 cm. The sensor module includes a high linearity pressure sensor and an ultra-low power 24-bit $\Delta\Sigma$ ADC with internal factory calibrated coefficients. It provides a precise digital 24-bit pressure and temperature value and different operation modes that allow the user to optimize for conversion speed and current consumption. A high-resolution temperature output allows the implementation in depth measurement systems and thermometer function without any additional sensor. The MS5807-30BA can be interfaced to virtually any microcontroller. The communication protocol is simple, without the need of programming internal registers in the device. The gel protection and antimagnetic stainless-steel cap make the module water resistant.

Small dimensions of only 3.3 x 3.3 x 2.75 mm allow integration in mobile devices. Enhanced construction and design materials allow for enhanced chemical endurance in applications with harsh liquid media environments with limited exposure. This sensor module generation is based on leading MEMS technology from TE proven experience and know-how in high volume manufacturing of sensors modules.

FEATURES

- Ceramic and metal package: 3.3 x 3.3 x 2.75mm
- High resolution module: 0.2 cm (in water)
- Supply voltage: 1.5 to 3.6 V
- Low power: 0.6 μ A (standby \leq 0.1 μ A at 25°C)
- Integrated digital pressure sensor (24-bit $\Delta\Sigma$ ADC)
- Operating range: 0 to 30 bar, -20 to +85 °C
- I²C interface
- No external components (internal oscillator)
- Water resistant sealing with 1.8 x 0.8mm O-ring
- High chemical endurance
- Shielded metal lid

APPLICATIONS

- Dive Computers
- Mobile Water Depth Measurement Systems
- Fitness Trackers
- Wearables

PERFORMANCE SPECIFICATIONS

ABSOLUTE MAXIMUM RATINGS

Parameter	Symbol	Conditions	Min.	Typ.	Max	Unit
Supply voltage	V _{DD}		-0.3		+4	V
Storage temperature	T _S		-40		+85	°C
Overpressure	P _{max}	ISO 6425 ⁽¹⁾			50	bar
Maximum Soldering Temperature ⁽²⁾	T _{max}	40 sec max			250	°C
ESD rating		Human Body Model	-2		+2	kV
Latch up		JEDEC standard No 78	-100		+100	mA

(1): Pressure ramp up/down min 60s

(2): Refer to application note 808

ELECTRICAL CHARACTERISTICS

Parameter	Symbol	Conditions	Min.	Typ.	Max	Unit
Operating Supply voltage	V _{DD}		1.5	3.0	3.6	V
Operating Temperature	T		-20	+25	+85	°C
Supply current (1 sample per sec.)	I _{DD}	OSR	8192	20.09		µA
			4096	10.05		
			2048	5.02		
			1024	2.51		
			512	1.26		
			256	0.63		
Peak supply current		during conversion		1.25		mA
Standby supply current		at 25°C (V _{DD} = 3.0V)		0.01	0.1	µA
Power supply hold off for internal reset ⁽³⁾		V _{DD} < 0.1V	200			ms
VDD Capacitor		From V _{DD} to GND	100	470		nF

(3): Supply voltage power up must be continuous from GND to VDD without any step

ANALOG DIGITAL CONVERTER (ADC)

Parameter	Symbol	Conditions	Min.	Typ.	Max	Unit	
Output Word				24		bit	
Conversion time ⁽⁴⁾	t _c	OSR	8192	14.80	16.44	18.08	ms
			4096	7.40	8.22	9.04	
			2048	3.72	4.13	4.54	
			1024	1.88	2.08	2.28	
			512	0.95	1.06	1.17	
			256	0.48	0.54	0.60	

(4): Maximum values must be used to determine waiting times in I2C communication

PERFORMANCE SPECIFICATIONS (CONTINUED)

PRESSURE OUTPUT CHARACTERISTICS (V_{DD} = 3 V, T = 25°C UNLESS OTHERWISE NOTED)

Parameter	Conditions		Min.	Typ.	Max	Unit
Operating Pressure Range		P _{range}	0		30	bar
Absolute Accuracy ⁽¹⁾⁽⁴⁾ , Temperature range: 0 ... 45°C	Version -01	0 ... 6 bar	-50		+50	mbar
	Version -26		-75		+75	mbar
Absolute Accuracy ⁽¹⁾⁽⁴⁾ , Temperature range: 0 ... 45°C		0 ... 20 bar	-100		+100	mbar
		0 ... 30 bar	-200		+200	
Absolute Accuracy ⁽¹⁾⁽⁴⁾ , Temperature range: -20 ... 85°C	Version -01	0 ... 6 bar	-100		+100	mbar
	Version -26		-150		+150	mbar
Absolute Accuracy ⁽¹⁾⁽⁴⁾ , Temperature range: -20 ... 85°C		0 ... 20 bar	-200		+200	mbar
		0 ... 30 bar	-400		+400	
Maximum error with supply voltage ⁽²⁾	Version -01	V _{DD} = 1.5 V ... 3.6 V		±30		mbar
	Version -26			±75		mbar
Long-term stability				±30		mbar/yr
Reflow soldering impact IPC/JEDEC J-STD-020C	Version -01			±8		mbar
	Version -26			±30		mbar
Recovering time after reflow ⁽³⁾				7		days
Resolution RMS	OSR	8192		0.20		mbar
		4096		0.28		
		2048		0.38		
		1024		0.54		
		512		0.84		
		256		1.57		

- (1) With autozero at one pressure point
- (2) With autozero at 3V point
- (3) Time to recover at least 66% of the reflow impact.
- (4) Wet/dry cycle: sensor must be dried typically once a day

TEMPERATURE OUTPUT CHARACTERISTICS (V_{DD} = 3 V, T = 25°C UNLESS OTHERWISE NOTED)

Parameter	Conditions		Min.	Typ.	Max	Unit
Absolute Accuracy	-20°C ... +85°C		-4		+4	°C
Maximum error with supply voltage	V _{DD} = 1.5 V ... 3.6 V			± 0.6		°C
Resolution RMS	OSR	8192		0.0022		°C
		4096		0.0026		
		2048		0.0033		
		1024		0.0041		
		512		0.0055		
		256		0.0086		

MS5837-30BA

Ultra-small, gel-filled pressure sensor with stainless steel cap

PERFORMANCE SPECIFICATIONS (CONTINUED)

DIGITAL INPUTS (SCL, SDA)

Parameter	Symbol	Conditions	Min.	Typ.	Max	Unit
Serial data clock	SCL				400	kHz
Input high voltage	V_{IH}		80% V_{DD}		100% V_{DD}	V
Input low voltage	V_{IL}		0% V_{DD}		20% V_{DD}	V
Input leakage current	$I_{leak25^{\circ}C}$	at 25°C			0.1	μA

DIGITAL OUTPUTS (SDA)

Parameter	Symbol	Conditions	Min.	Typ.	Max	Unit
Output high voltage	V_{OH}	$I_{source} = 0.6 \text{ mA}$	80% V_{DD}		100% V_{DD}	V
Output low voltage	V_{OL}	$I_{sink} = 0.6 \text{ mA}$	0% V_{DD}		20% V_{DD}	V

TYPICAL PERFORMANCE CHARACTERISTICS

PRESSURE ERROR VS PRESSURE AND TEMPERATURE

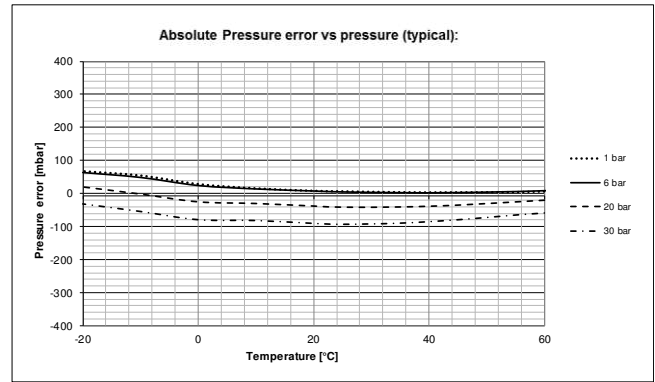
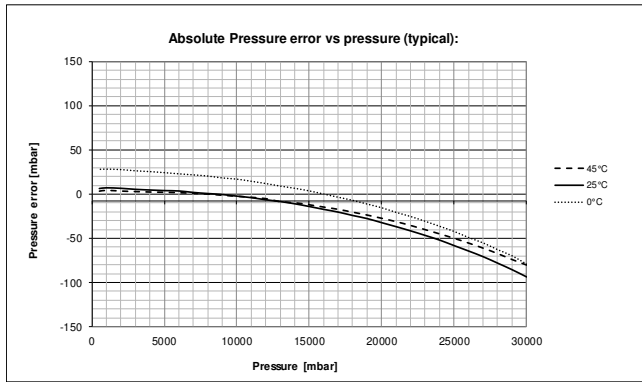

TEMPERATURE ERROR VS PRESSURE AND TEMPERATURE

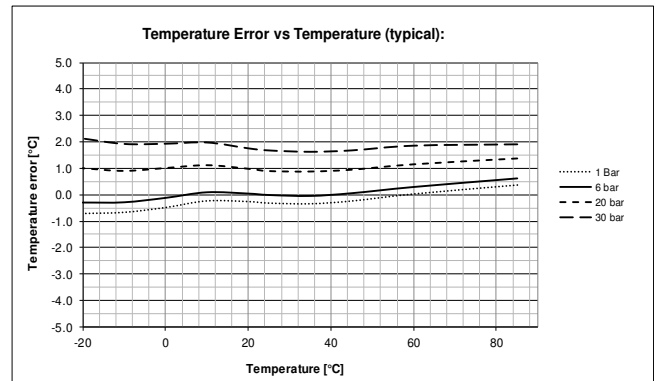
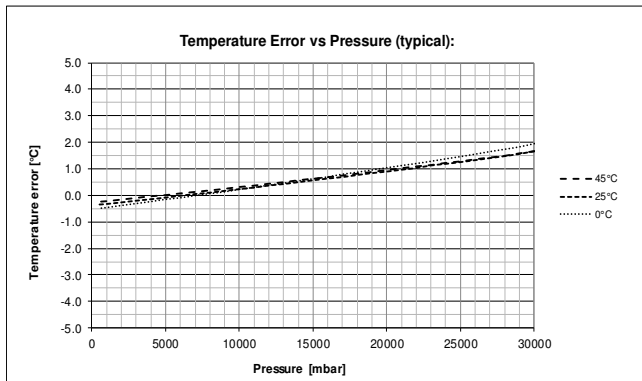

PRESSURE AND TEMPERATURE VS SUPPLY VOLTAGE

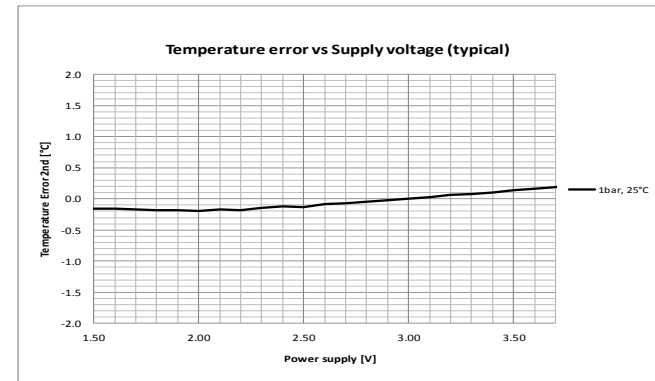
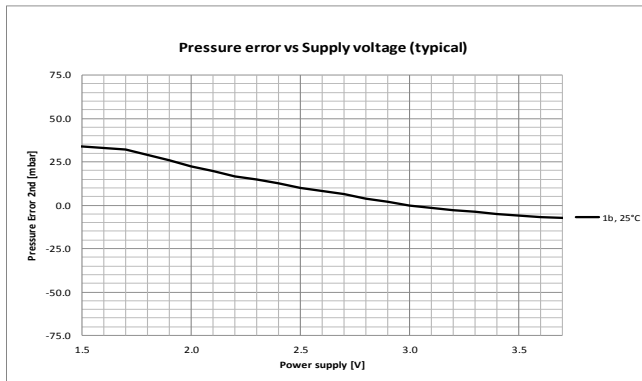

MS5837-30BA

Ultra-small, gel-filled pressure sensor with stainless steel cap

FUNCTIONAL DESCRIPTION

GENERAL

The MS5837-30BA consists of a piezo-resistive sensor and a sensor interface IC. The main function of the MS5837-30BA is to convert the uncompensated analog output voltage from the piezo-resistive pressure sensor to a 24-bit digital value, as well as providing a 24-bit digital value for the temperature of the sensor

FACTORY CALIBRATION

Every module is individually factory calibrated at two temperatures and two pressures. As a result, 6 coefficients necessary to compensate for process variations and temperature variations are calculated and stored in the 112-bit PROM of each module. These bits (partitioned into 6 coefficients W1 to W6) must be read by the microcontroller software and used in the program converting D1 and D2 into compensated pressure and temperature values. The coefficients W0 is for factory configuration and CRC.

SERIAL I²C INTERFACE

The external microcontroller clocks in the data through the input SCL (Serial CLock) and SDA (Serial DATa). The sensor responds on the same pin SDA which is bidirectional for the I²C bus interface. So this interface type uses only 2 signal lines and does not require a chip select.

Module ref	Mode	Pins used	Address (7 bits)
MS5837-30BA	I ² C	SDA, SCL	0x76 (1110110 b)

COMMANDS

The MS5837-30BA has only five basic commands:

1. Reset
2. Read PROM (128 bit of calibration words)
3. D1 conversion
4. D2 conversion
5. Read ADC result (24 bit pressure / temperature)

Size of each command is 1 byte (8 bits) as described in the table below. After ADC read commands the device will return 24 bit result and after the PROM read 16bit result. The address of the PROM is embedded inside of the PROM read command using the a2, a1 and a0 bits.

Bit number	Command byte								hex value
	0	1	2	3	4	5	6	7	
Bit name	PR M	COV	-	Typ	Ad2/ Os2	Ad1/ Os1	Ad0/ Os0	Stop	
Command									
Reset	0	0	0	1	1	1	1	0	0x1E
Convert D1 (OSR=256)	0	1	0	0	0	0	0	0	0x40
Convert D1 (OSR=512)	0	1	0	0	0	0	1	0	0x42
Convert D1 (OSR=1024)	0	1	0	0	0	1	0	0	0x44
Convert D1 (OSR=2048)	0	1	0	0	0	1	1	0	0x46
Convert D1 (OSR=4096)	0	1	0	0	1	0	0	0	0x48
Convert D2 (OSR=256)	0	1	0	1	0	0	0	0	0x50
Convert D2 (OSR=512)	0	1	0	1	0	0	1	0	0x52
Convert D2 (OSR=1024)	0	1	0	1	0	1	0	0	0x54
Convert D2 (OSR=2048)	0	1	0	1	0	1	1	0	0x56
Convert D2 (OSR=4096)	0	1	0	1	1	0	0	0	0x58
ADC Read	0	0	0	0	0	0	0	0	0x00
PROM Read	1	0	1	0	Ad2	Ad1	Ad0	0	0xA0 to 0xAC

Figure 1: Command Structure

I²C INTERFACE

RESET SEQUENCE

The Reset sequence shall be sent once after power-on to make sure that the calibration PROM gets loaded into the internal register. It can be also used to reset the device PROM from an unknown condition.

The reset can be sent at any time. In the event that there is not a successful power on reset this may be caused by the SDA being blocked by the module in the acknowledge state. The only way to get the MS5837-30BA to function is to send several SCLs followed by a reset sequence or to repeat power on reset.

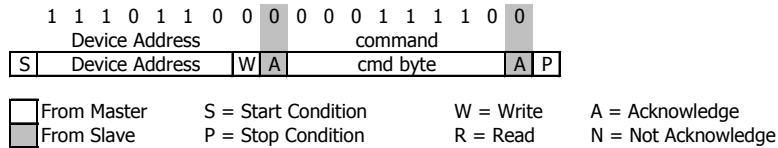

Figure 2: I²C Reset Command

PROM READ SEQUENCE

The read command for PROM shall be executed once after reset by the user to read the content of the calibration PROM and to calculate the calibration coefficients. There are in total 7 addresses resulting in a total memory of 112 bit. Addresses contain factory data and the setup, calibration coefficients, the serial code and CRC. The command sequence is 8 bits long with a 16 bit result which is clocked with the MSB first. The PROM Read command consists of two parts. First command sets up the system into PROM read mode. The second part gets the data from the system.

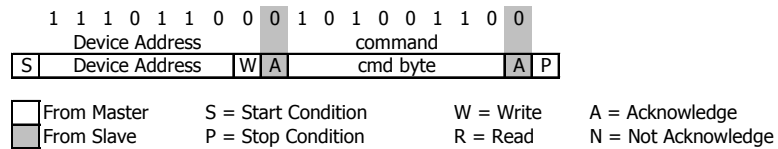

Figure 3: I²C Command to read memory address= 011

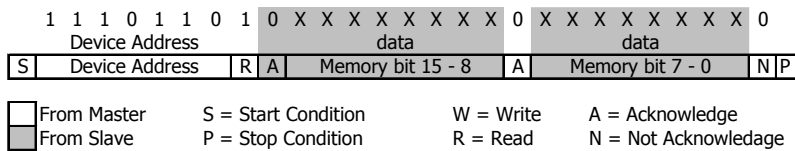

Figure 4: I²C answer from MS5837-30BA

CONVERSION SEQUENCE

The conversion command is used to initiate uncompensated pressure (D1) or uncompensated temperature (D2) conversion. After the conversion, using ADC read command the result is clocked out with the MSB first. If the conversion is not executed before the ADC read command, or the ADC read command is repeated, it will give 0 as the output result. If the ADC read command is sent during conversion the result will be 0, the conversion will not stop and the final result will be wrong. Conversion sequence sent during the already started conversion process will yield incorrect result as well. A conversion can be started by sending the command to MS5837-30BA. When command is sent to the system it stays busy until conversion is done. When conversion is finished the data can be accessed by sending a Read command, when acknowledge is sent from the MS5837-30BA, 24 SCL cycles may be sent to receive all result bits. Every 8 bits the system waits for an acknowledge signal.

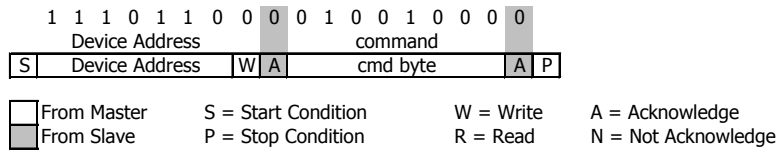

Figure 5: I²C command to initiate a pressure conversion (OSR=4096, typ=D1)

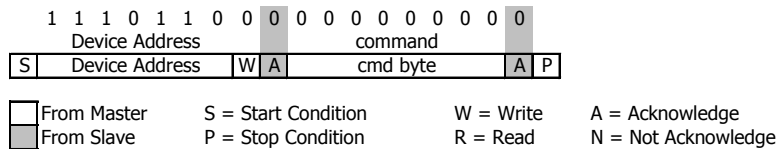

Figure 6: I²C ADC read sequence

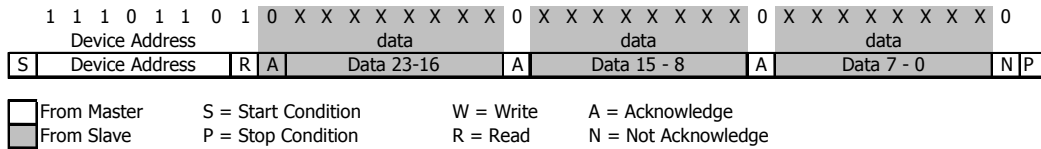

Figure 7: I²C answer from MS5837-30BA

Version PROM Word 0 programming

For product type, the bits [11:5] of memory address 0 must be programmed with the following fixed values:

MS5837-30BA26

Address	15	14	13	12	11	10	9	8	7	6	5	4	3	2	1	0
0	crc				0	0	1	1	0	1	0	factory settings				

CYCLIC REDUNDANCY CHECK (CRC)

MS5837-30BA contains a PROM memory with 112-Bit. A 4-bit CRC has been implemented to check the data validity in memory. The besides C code describes in detail CRC-4 calculation.

	D B 1 5	D B 1 4	D B 1 3	D B 1 2	D B 1 1	D B 1 0	D B 9	D B 8	D B 7	D B 6	D B 5	D B 4	D B 3	D B 2	D B 1	D B 0
0	CRC			Factory defined												
1	C1															
2	C2															
3	C3															
4	C4															
5	C5															
6	C6															

Figure 8: Memory PROM mapping

C Code example for CRC-4 calculation:

```

unsigned char crc4(unsigned int n_prom[]) // n_prom defined as 8x unsigned int (n_prom[8])
{
int cnt; // simple counter
unsigned int n_rem=0; // crc remainder
unsigned char n_bit;

n_prom[0]=((n_prom[0]) & 0x0FFF); // CRC byte is replaced by 0
n_prom[7]=0; // Subsidiary value, set to 0
for (cnt = 0; cnt < 16; cnt++) // operation is performed on bytes
    { // choose LSB or MSB

        if (cnt%2==1) n_rem ^= (unsigned short) ((n_prom[cnt]>>1]) & 0x00FF);
        else n_rem ^= (unsigned short) (n_prom[cnt]>>1]>>8);
        for (n_bit = 8; n_bit > 0; n_bit--)
            {
                if (n_rem & (0x8000)) n_rem = (n_rem << 1) ^ 0x3000;
                else n_rem = (n_rem << 1);
            }
    }
n_rem= ((n_rem >> 12) & 0x000F); // final 4-bit remainder is CRC code
return (n_rem ^ 0x00);
}
    
```

PRESSURE AND TEMPERATURE CALCULATION

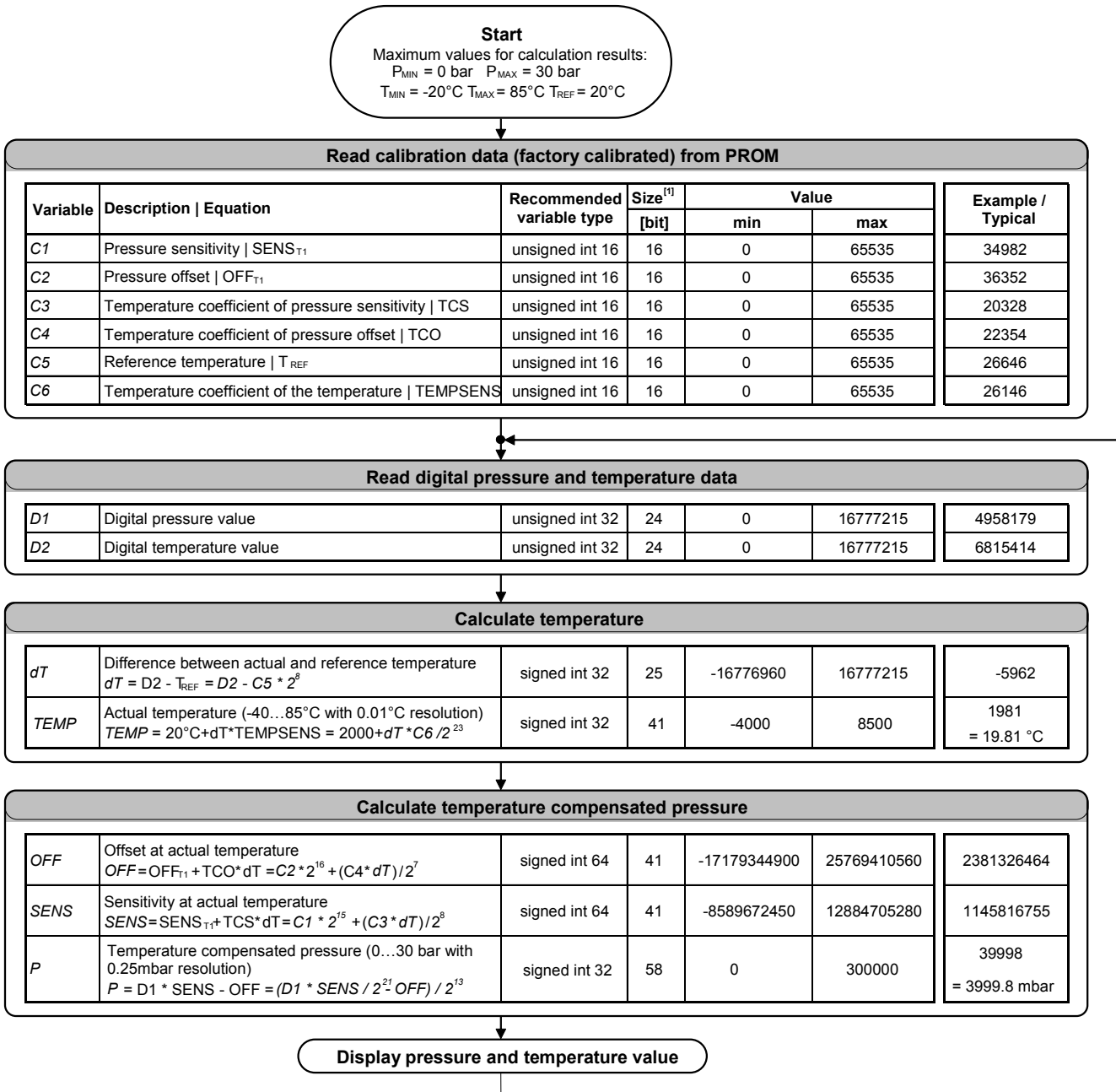

Notes
 [1] Maximal size of intermediate result during evaluation of variable

Figure 9: Flow chart for pressure and temperature reading and software compensation.

SECOND ORDER TEMPERATURE COMPENSATION

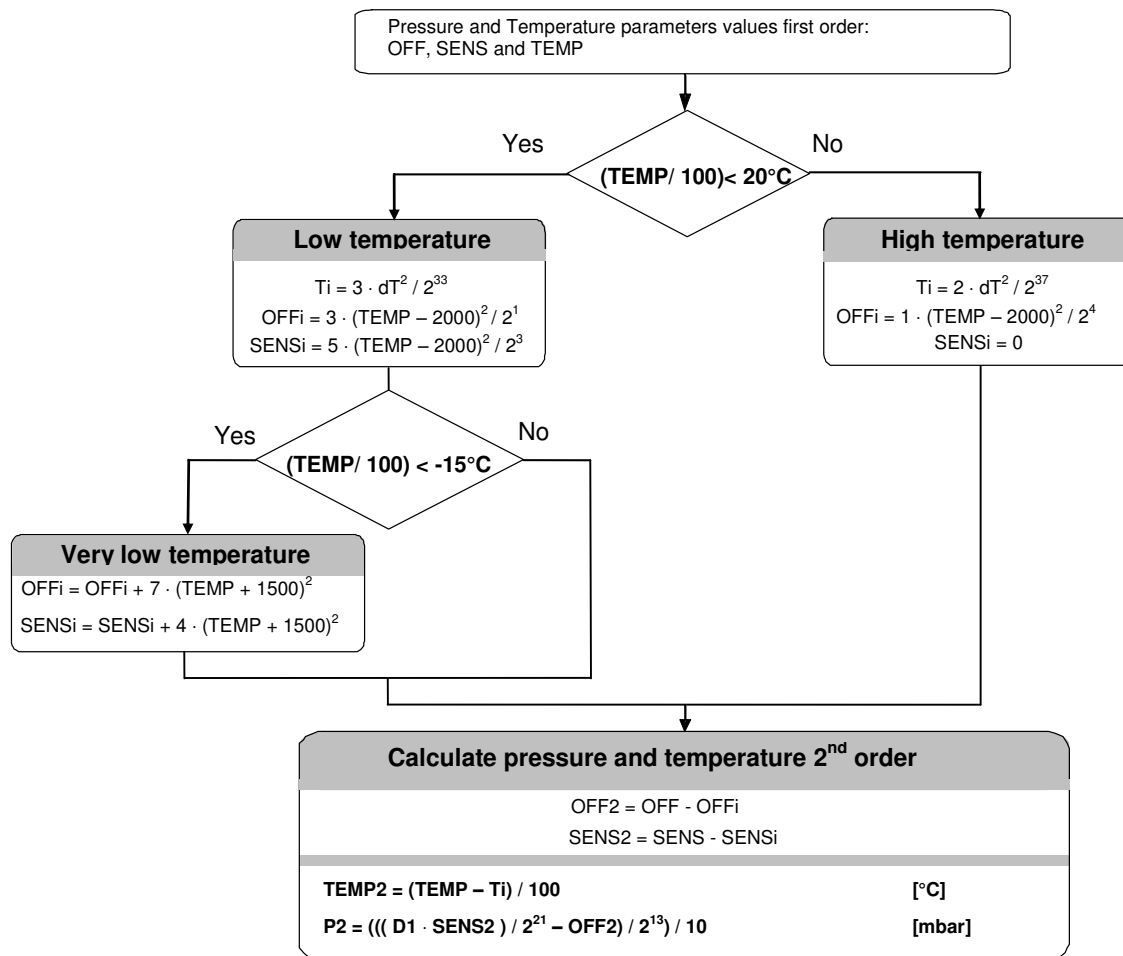

Figure 10: Flow chart for pressure and temperature to the optimum accuracy.

MS5837-30BA

Ultra-small, gel-filled pressure sensor with stainless steel cap

APPLICATION CIRCUIT

The MS5837 is a circuit that can be used in conjunction with a microcontroller in mobile altimeter applications.

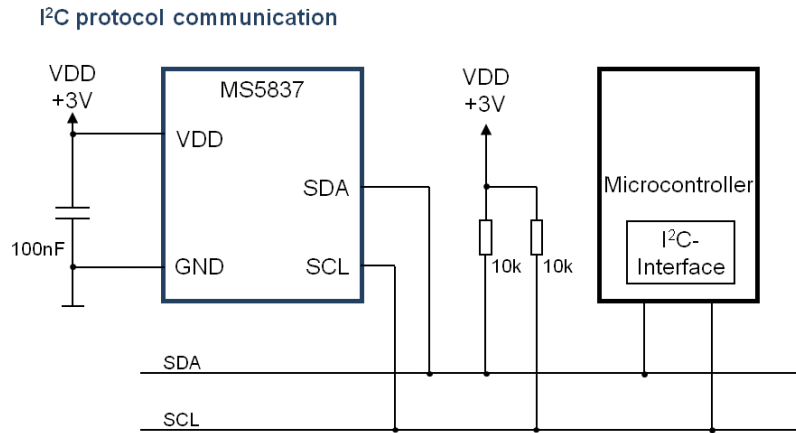
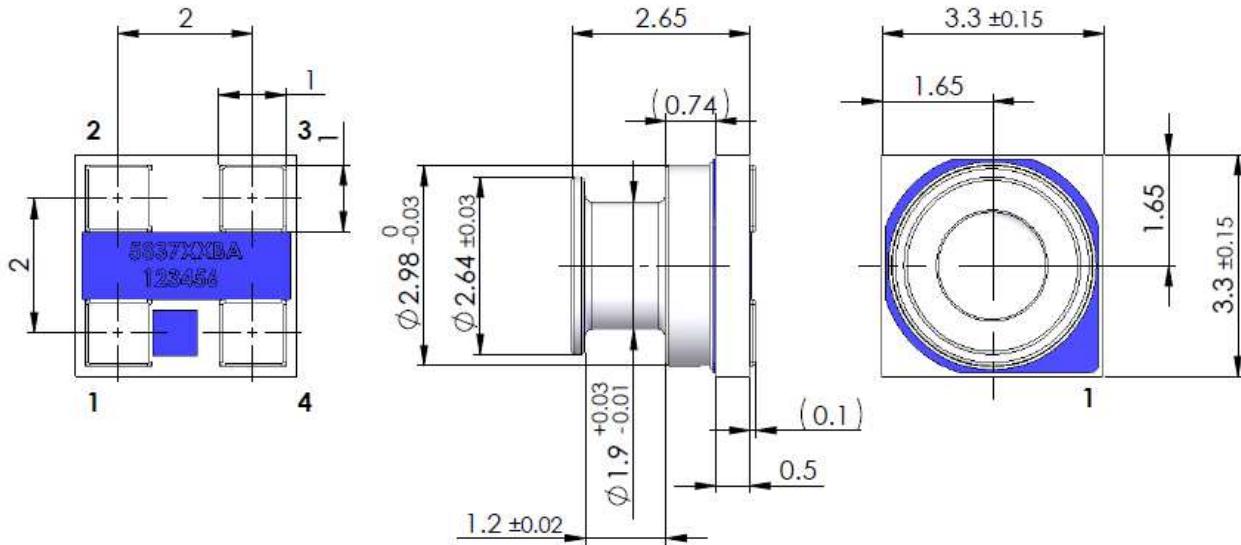

Figure 11: Typical application circuit

PIN CONFIGURATION AND DEVICE PACKAGE OUTLINE

UNLESS OTHERWISE SPECIFIED DIMENSIONS ARE IN MILLIMETERS. GENERAL TOLERANCE ± 0.1



1	GND	GROUND
2	VDD	POSITIVE SUPPLY
3	SCL	I ² C CLOCK
4	SDA	I ² C DATA

Figure 12: Package outlines and Pin configuration

MS5837-30BA

Ultra-small, gel-filled pressure sensor with stainless steel cap

RECOMMENDED PAD LAYOUT

Pad layout for bottom side of the MS5837-30BA soldered onto printed circuit board.

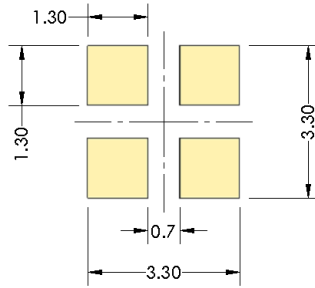
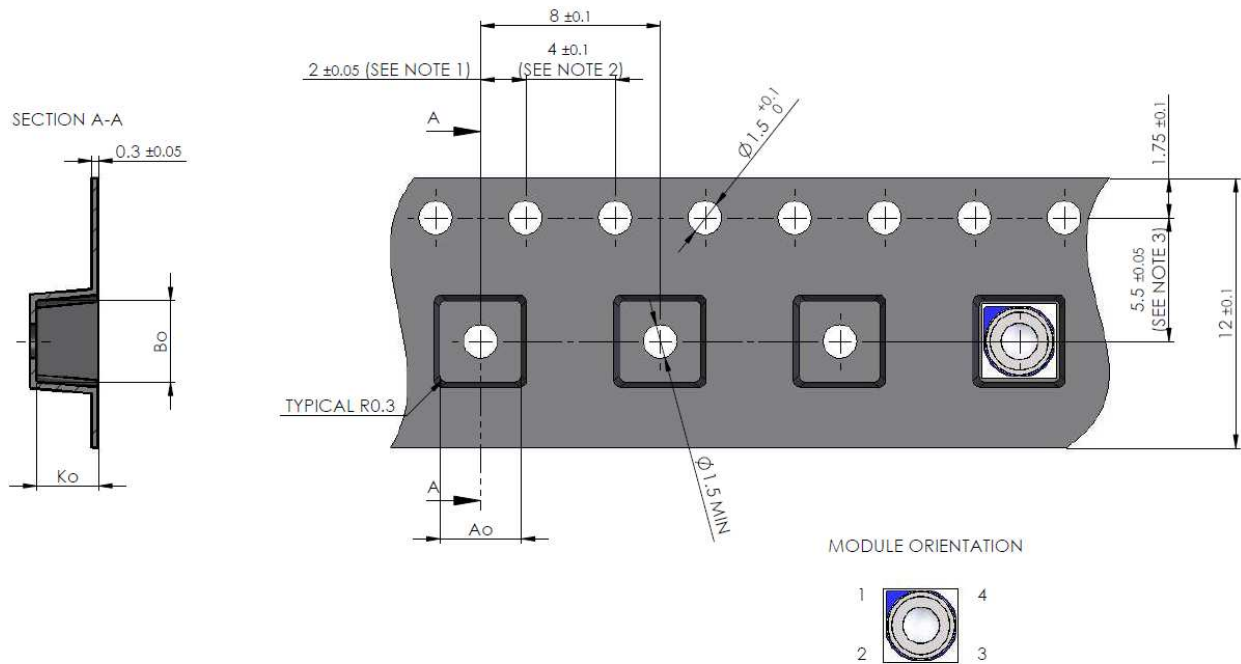

Figure 13: Pad layout

SHIPPING PACKAGE



A ₀	3.6±0.1
B ₀	3.6±0.1
K ₀	2.75±0.1

NOTE:

- 1: Measured from centerline of sprocket hole to centerline of pocket
- 2: Cumulative tolerance of 10 sprocket holes is ±0.2mm
- 3: Measured from centerline of sprocket hole to centerline of pocket

MS5837-30BA

Ultra-small, gel-filled pressure sensor with stainless steel cap

MOUNTING AND ASSEMBLY CONSIDERATIONS

SOLDERING

Please refer to the application note AN808 available on our website for all soldering recommendations.

MOUNTING

The MS5837-30BA can be placed with automatic Pick & Place equipment using vacuum nozzles. It will not be damaged by the vacuum. Due to the low stress assembly the sensor does not show pressure hysteresis effects. It is important to solder all contact pads.

CONNECTION TO PCB

The package outline of the module allows the use of a flexible PCB for interconnection. This can be important for applications in watches and other special devices.

SEALING WITH O-RINGS

In applications such as outdoor watches the electronics must be protected against direct water or humidity. For such applications the MS5837-30BA provides the possibility to seal with an O-ring. The O-ring shall be placed at the groove location, i.e. the small outer diameter of the metal lid. The following O-ring / housing dimensions are recommended:

O-ring inner diameter	1.8 ± 0.05 mm
O-ring cross-section diameter	0.8 ± 0.03 mm
Housing bore diameter	3.07 ± 0.03 mm

Please refer to the application note available on our website for O-ring mounting recommendations.

CLEANING

The MS5837-30BA has been manufactured under clean-room conditions. It is therefore recommended to assemble the sensor under class 10'000 or better conditions. Should this not be possible, it is recommended to protect the sensor opening during assembly from entering particles and dust. To avoid cleaning of the PCB, solder paste of type "no-clean" shall be used. Warning: cleaning might damage the sensor.

ESD PRECAUTIONS

The electrical contact pads are protected against ESD. It is therefore essential to ground machines and personnel properly during assembly and handling of the device. The MS5837-30BA is shipped in antistatic transport boxes. Any test adapters or production transport boxes used during the assembly of the sensor shall be of an equivalent antistatic material.

DECOUPLING CAPACITOR

Particular care must be taken when connecting the device to the power supply. A minimum of 100nF ceramic capacitor must be placed as close as possible to the MS5837-30BA VDD pin. This capacitor will stabilize the power supply during data conversion and thus, provide the highest possible accuracy.

MS5837-30BA

Ultra-small, gel-filled pressure sensor with stainless steel cap

ORDERING INFORMATION

PART NUMBER	DESCRIPTION	SHIELDING	HIGH ENDURANCE
20001149-00	MS5837-30BA26 30BA HE LS T&R PRESS SEN	X	X



株式会社 **クローネ**

■カタログに掲載してある製品の色は印刷インキの関係上、実際とは異なる場合があります。

■製品のデザイン、仕様等などは、予告なく変更する場合があります。

本 社：〒124-0023 東京都葛飾区東新小岩3丁目9番6号 TEL:(03) 3695-5431 / FAX:(03) 3695-5698

大阪支店：〒530-0054 大阪市北区南森町2-2-9(南森町八千代ビル7F) TEL:(06) 6361-4831 / FAX:(06) 6361-9360

e-mail: sales-tokyo@krone.co.jp URL: <https://www.krone.co.jp>

te.com/sensorsolutions

Measurement Specialties (MEAS), TE Connectivity, TE Connectivity (logo) and EVERY CONNECTION COUNTS are trademarks. All other logos, products and/or company names referred to herein might be trademarks of their respective owners.

The information given herein, including drawings, illustrations and schematics which are intended for illustration purposes only, is believed to be reliable. However, TE Connectivity makes no warranties as to its accuracy or completeness and disclaims any liability in connection with its use. TE Connectivity's obligations shall only be as set forth in TE Connectivity's Standard Terms and Conditions of Sale for this product and in no case will TE Connectivity be liable for any incidental, indirect or consequential damages arising out of the sale, resale, use or misuse of the product. Users of TE Connectivity products should make their own evaluation to determine the suitability of each such product for the specific application.

© 2019 TE Connectivity Ltd. family of companies All Rights Reserved.