

Trigas DM

Durchflussmesser-Manufaktur



DML-SERIES

PELTON WHEEL FLOWMETERS

FOR MEASUREMENTS AS LOW AS **3.8 ML/MIN**

Datasheet

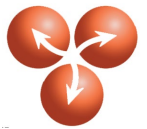

Flow meter manufacture

As a specialist in flow measurement technology, TrigasDM supplies high-quality measuring instruments, electronics and calibrators for liquids and gases.

Made in Germany

Our products are exclusively developed and manufactured in Neufahrn, 20 km north of Munich, ensuring world-class technical know-how for our customers.



Contact

We are proud of our high-quality products and friendly customer service and welcome you as a valued customer to our growing family. You can benefit from our long-standing experience and our comprehensive technical support.

TrigasDM GmbH
Erdinger Str. 2b

85375 Neufahrn, Germany

Tel.: +49 8165 9999 300
Fax: +49 8165 9999 369
Email: info@trigasdm.com
www.trigasdm.com

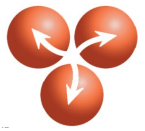

The DML Series is a special turbine version for high accurate measuring of very low flow ranges of liquids and gases.

Pelton Wheel flowmeter

Are the ideal solution for measuring applications in liquids when high accuracy, very fast response times, compact design and high reliability are required with either continuous or rapidly changing flow as well as fluctuating operating temperature and pressure. A variety of end fitting options allows the measuring instruments to be easily connected to the process piping.

Applications

The DML-Series turbine flowmeters are suited for a wide range of applications. These include monitoring of fuel, coolants and lubricants in engine development and construction, measurement of dosing quantities in the food and pharmaceutical sector, monitoring and measurement of high-purity water in the research and development sector, diesel consumption calculations and much more.

Advantages

- Pelton Wheel Rotor
- Jewel bearing
- Wide measuring range
- Measurement of very low flow rates
- Interference-free signal transmission (no-drift, digital pulse output).
- Integrated temperature sensor in the pickoff for real time correction of the effects of temperature and viscosity changes

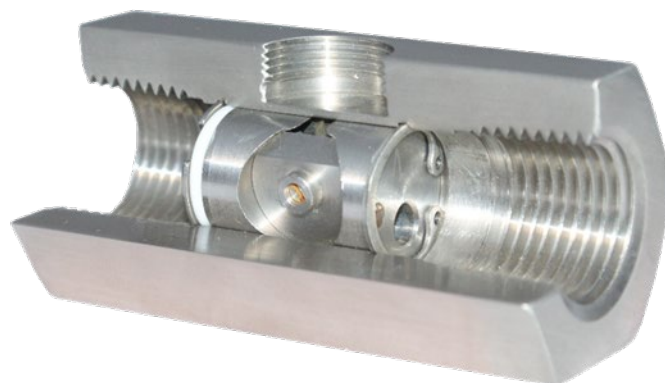
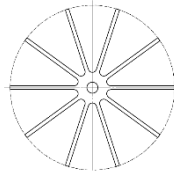

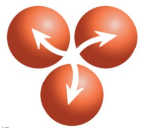

Technical data

Flow range:	see "Measuring ranges" table
Response time:	<4 ms
Temperature range:	-50 °C to +150 °C
Operating pressure:	up to 400 bar, Depending on connection, optionally also higher pressures possible
Viscosity:	Each turbine is calibrated according to customer specifications and delivered with individual calibration protocols. (Standard viscosity: 1.3 mm ² /s)

Liquid

Calibration accuracy:	≤±0,05% of measured value
Repeatability:	≤±0,1% of measured value
Accuracy:	≤±0,25% of measured value in 10:1 flow range
Linearity:	≤±0.1% of the measured value with linearization electronics

Gas

Calibration accuracy:	≤±0, 3% of measured value
Repeatability:	≤±0,2% of measured value
Accuracy:	≤±0,60% of measured value in 10:1 flow range
Linearity:	≤±0,1% of the measured value with linearization electronics
Standard material:	Stainless steel

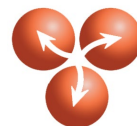

Measuring ranges

a) Gas

 Model	Standard Range		Extended Range		K-Factor¹⁾	max. Frequency¹⁾
	[ml/min]		[ml/min]			
	min.	max.	min.	max.	[Pulse/ml]	[Hz]
DML0.6	42,5	425	-	-	170	1200
DML1.0	70,8	708	57	848	85	1000
DML2.0	141,5	1415	99	1698	36	860
DML4.0	339,8	3398	226	5663	14	760
DML5.0	566,3	5663	425	8495	8,5	800

¹⁾ The K-factors and frequency data are average values. Each turbine is calibrated according to customer specification and delivered with individual calibration protocols

b) Liquid – Jewel Bearing (Bearing Code C)

 Model	Standard Range		Extended Range		K-Factor¹⁾	max. Frequency¹⁾
	[ml/min]		[ml/min]			
	min.	max.	min.	max.	[Pulse/ml]	[Hz]
DML0.6	7,57	75,7	3,8	303	211	270
DML1.0	30,3	303	11	605	119	600
DML2.0	94,6	946	38	1514	48	750
DML4.0	302,8	3028	76	4920	15	650
DML5.0	567,7	5677	189	7570	9	825

¹⁾ The K-factors and frequency data are average values. Each turbine is calibrated according to customer specification and delivered with individual calibration protocols

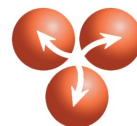

c) Liquid – Ball Bearing (Bearing Code A)

 Model	Standard Range		Extended Range		K-Factor¹⁾	max. Frequency¹⁾
	[ml/min]		[ml/min]		[Pulse/ml]	[Hz]
	min.	max.	min.	max.		
DML0.6	7,57	75,7	7,75	303	211	270
DML1.0	30,3	303	18,9	605	119	600
DML2.0	94,6	946	75,7	1514	48	750
DML4.0	302,8	3028	189,2	4920	15	650
DML5.0	567,7	5677	378,5	7570	9	825

¹⁾ The K-factors and frequency data are average values. Each turbine is calibrated according to customer specification and delivered with individual calibration protocols

d) Liquid – Journal Bearing (Bearing Code D,E & G)

 Model	Standard Range		Extended Range		K-Factor¹⁾	max. Frequency¹⁾
	[ml/min]		[ml/min]		[Pulse/ml]	[Hz]
	min.	max.	min.	max.		
DML2.0	151,4	1514	113,5	1514	48	750
DML4.0	492	4920	378,5	4920	15	650
DML5.0	567,7	5677	567,7	7570	9	825

¹⁾ The K-factors and frequency data are average values. Each turbine is calibrated according to customer specification and delivered with individual calibration protocols

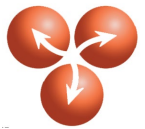

Dimensions

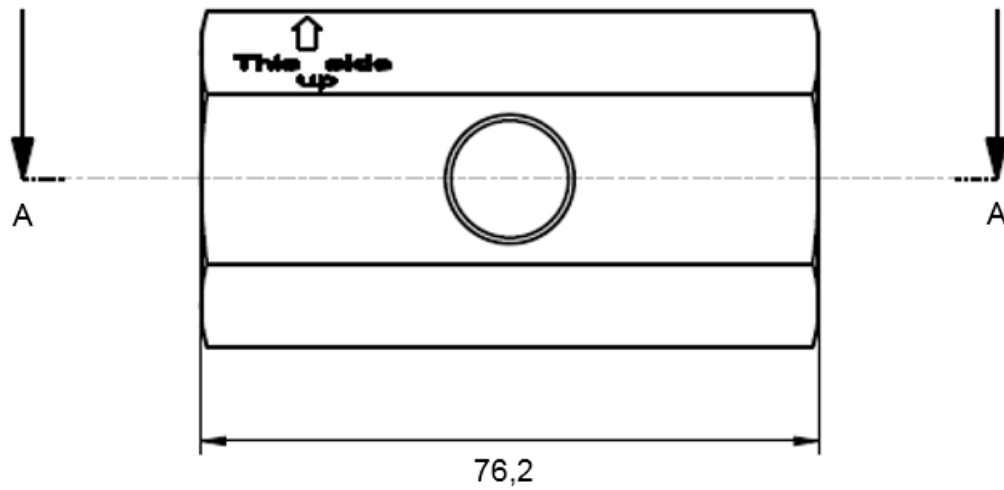

Align while installing
align

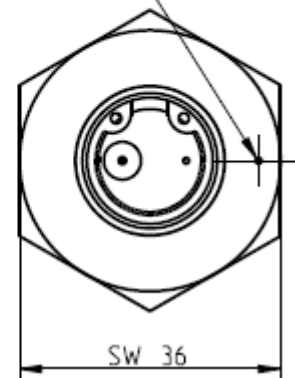

Model	InnerØ [mm]	Housing [mm]		Measuring sensor (pickoff)	
		length A	height/depth B ¹⁾	Screw in depth [mm]	Thread Type
DML0.6	0,6	76,2	SW 36*	17,7	5/8"-18UNF-2B
DML1.0	1,0				
DML2.0	2,0				
DML4.0	4,0				
DML5.0	5,0				

1) The total height is calculated from the height (B) of the flow meter plus measuring element minus the screw-in depth.

*) AF = Width across flats

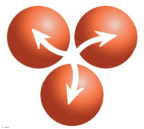

End Fitting types and operating pressure

Female threads (GF)

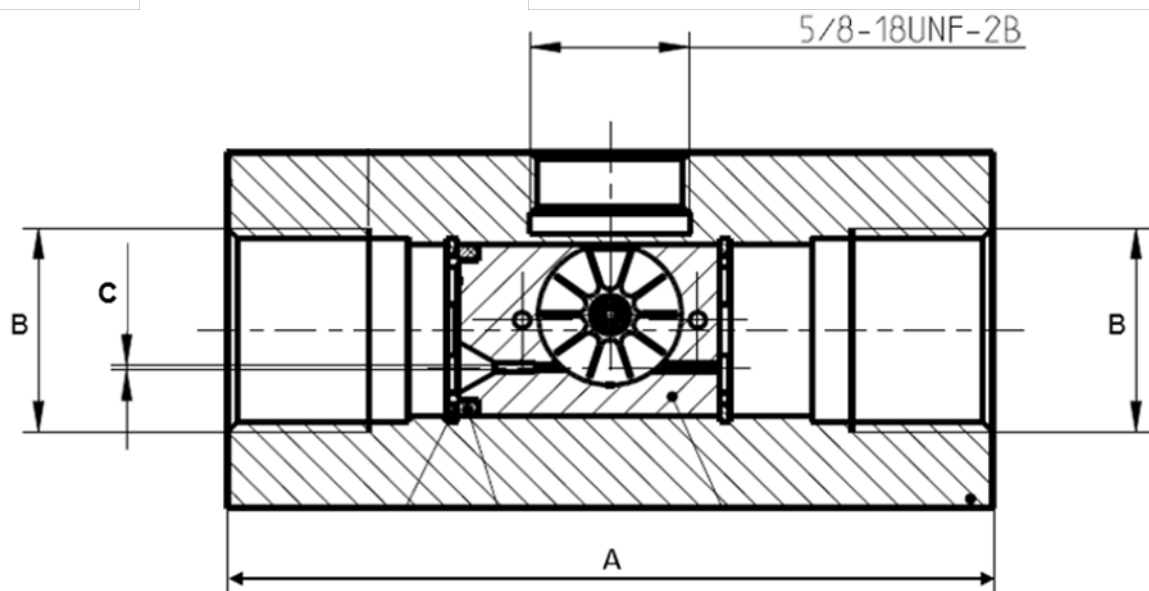

Model	A [mm]	B [Inch]	C [mm]	max. operating pressure [bar]
DML0.6	76,2	G1/2" (20,955mm)	0,6	400
DML1.0			1,0	
DML2.0			2,0	
DML4.0			4,0	
DML5.0			5,0	

NOTE

Other end fittings can be supplied on request

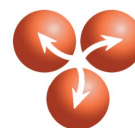

Piping Configuration

Turbine flow meters can be affected by the velocity profile of the fluid being measured. Installation with proper pipe runs will reduce or completely eliminate flow profile induced measurement errors during calibration and operation.

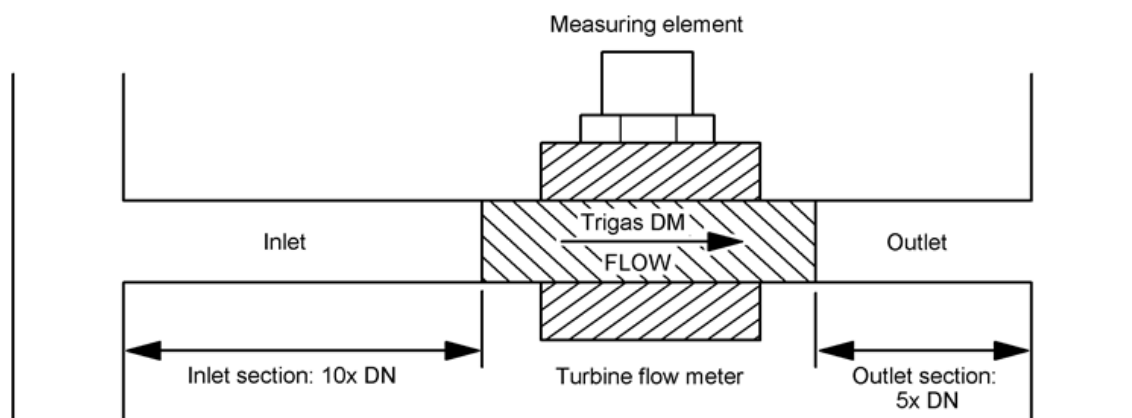

Inlet section and outlet section, schematic diagram

A straight run of pipe of at least 10 times the pipe diameter in an upstream direction, and 5 times the pipe diameter in a downstream direction are recommended (see figure and table). The upstream section should be fitted with flow straightening vane.

Appropriate flow straightening sets (up- and downstream) are available on request.

Contamination / filter

- All pipe sections and components in the metering line must be cleaned prior to the installation of the flow meter. Pipe Sealants, metal shavings and slag can damage the flow meter.
- If the cleanliness of the fluid cannot be guaranteed, a filter should be installed upstream of the flow meter, subject to the diameter of the flow meter. The selection of the filter depends on the precision opening of the flow meter and the bearing of the rotor. Contamination between the inside of the housing and Pelton wheel can lead to a blockage of the flow.
- A filter must always be used for gas measurements

Model	InnerØ [mm]	Filter mesh size for Jewels Pivot bearing	Filter mesh size for Ball bearings
DML0.6	0,6	min. 100 Micrometer	min. 10 Micrometer
DML1.0	1,0		
DML2.0	2,0		
DML4.0	4,0		
DML5.0	5,0		

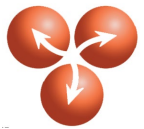

Explosion protection (ATEX)

- All DM-Series turbine flow meters are available in intrinsically safe design.
- The design consists of the turbine flow meter and the ATEX Pickoff. The following type of protection applies to this construction:
 - **Flow Sensor ATEX: II 1G Ex ia IIC (Zone 0,1,2)**
 - **Temperature Sensor ATEX: EX II 2G Ex ib IIC T4 Gb (Zone 1,2)**
- The turbine flow meter is installed in the hazardous area.
- The mounting of the barrier and the TriLIN is carried out in the safe area.
- Without barriers, the turbine flow meter must not be operated in the hazardous area.
- Cable lengths of up to 400 m are possible depending on the safety barrier used.

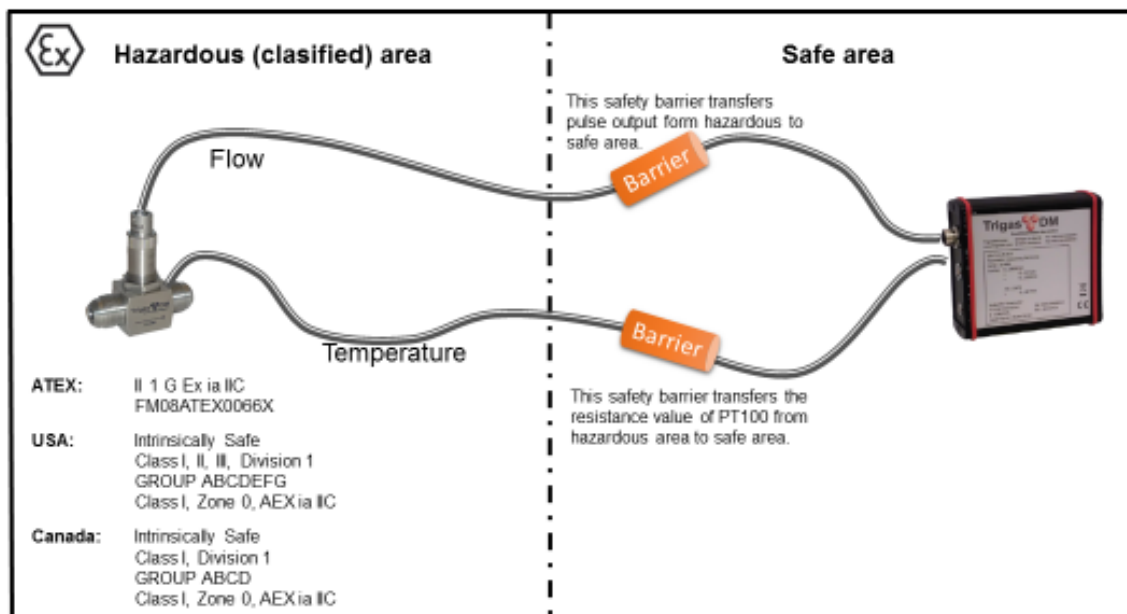

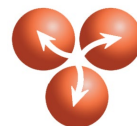

Model Numbering key

DML-Series (e.g. DML-0.6GF-BA-1)

Type code:	#1	#2	#3	#4	#5

Example:	DML	-0,6	-GF	-BA	-1

1	Code		
Type	DML		
2	Code	Size / Measuring range liquids	Measuring range gas
Pelton wheel	-0.6	iØ 0.6 mm; up to 303 ml/min	up to 425 ml/min
	-1.0	iØ 1.0 mm; up to 605 ml/min	up to 848 ml/min
	-2.0	iØ 2.0 mm, up to 1514 ml/min	up to 1698 ml/min
	-4.0	iØ 4.0 mm, up to 4920 ml/min	up to 5663 ml/min
	-5.0	iØ 5.0 mm, up to 7570 ml/min	up to 8495 ml/min
3	Code	Process connection	Restrictions
Process connection	-AN	Male thread	on request
	-HS	Hose connection	on request
	-GF	Female thread	
4	Code	Bearings	Restrictions
Bearings	-BC	Bearings, ceramic	only for liquids
	-BA	Bearings, stainless steel	only for liquids, on request
	-JP	Jewel bearings	
5	Code	Material housing and internals	Restrictions
Material	-1	Stainless steel	